

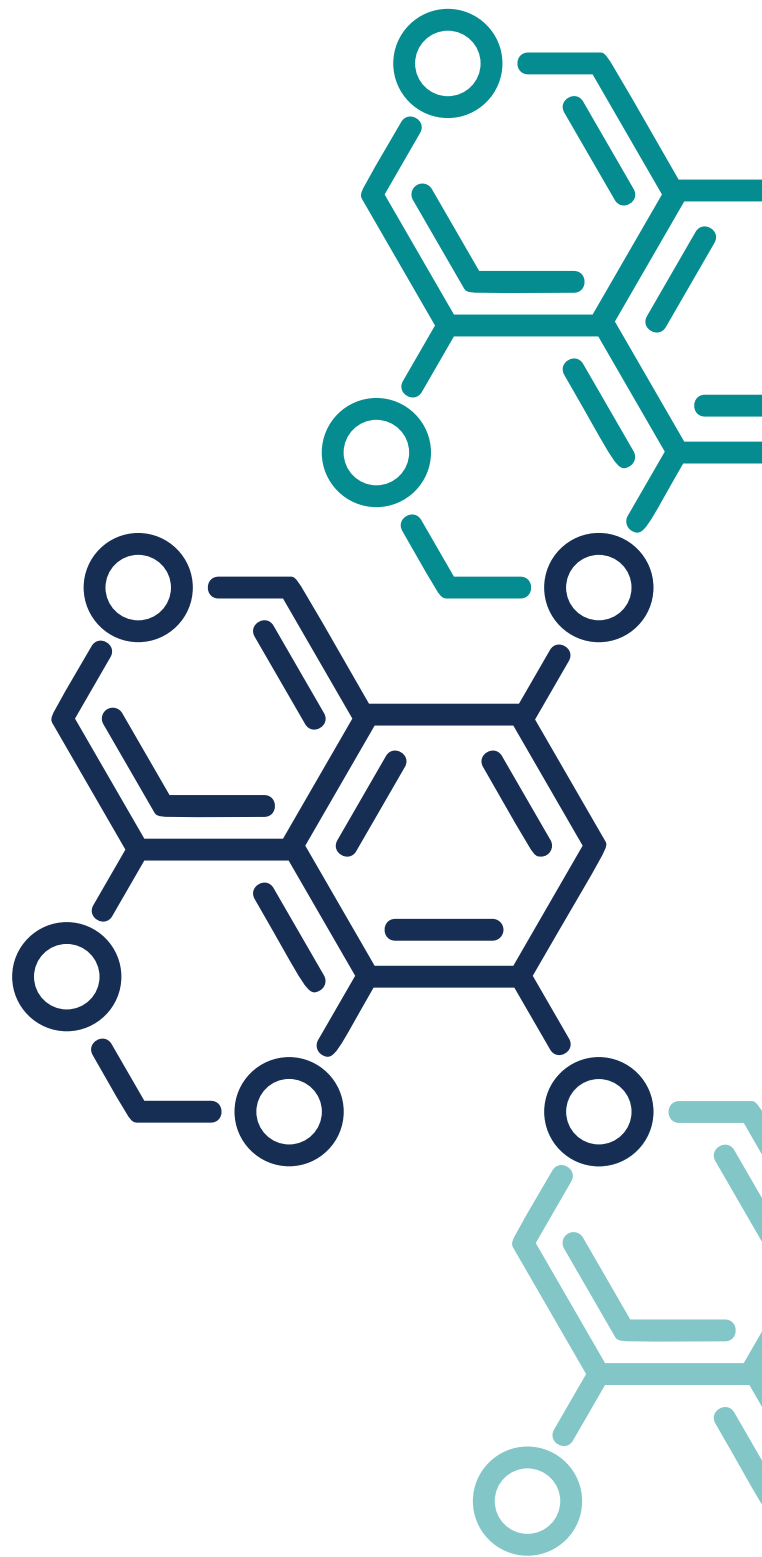

TRAUMA CATALOGUE
CATALOGO TRAUMA

2023 - 2024



Index

pag. 5	LOWER LIMB
pag. 15	FOOT
pag. 33	UPPER LIMB
pag. 45	BASIC TRAUMA
pag. 71	REGENERATIVE MEDICINE

Indice

ARTO INFERIORE
PIEDE
ARTO SUPERIORE
TRAUMA DI BASE
MEDICINA RIGENERATIVA

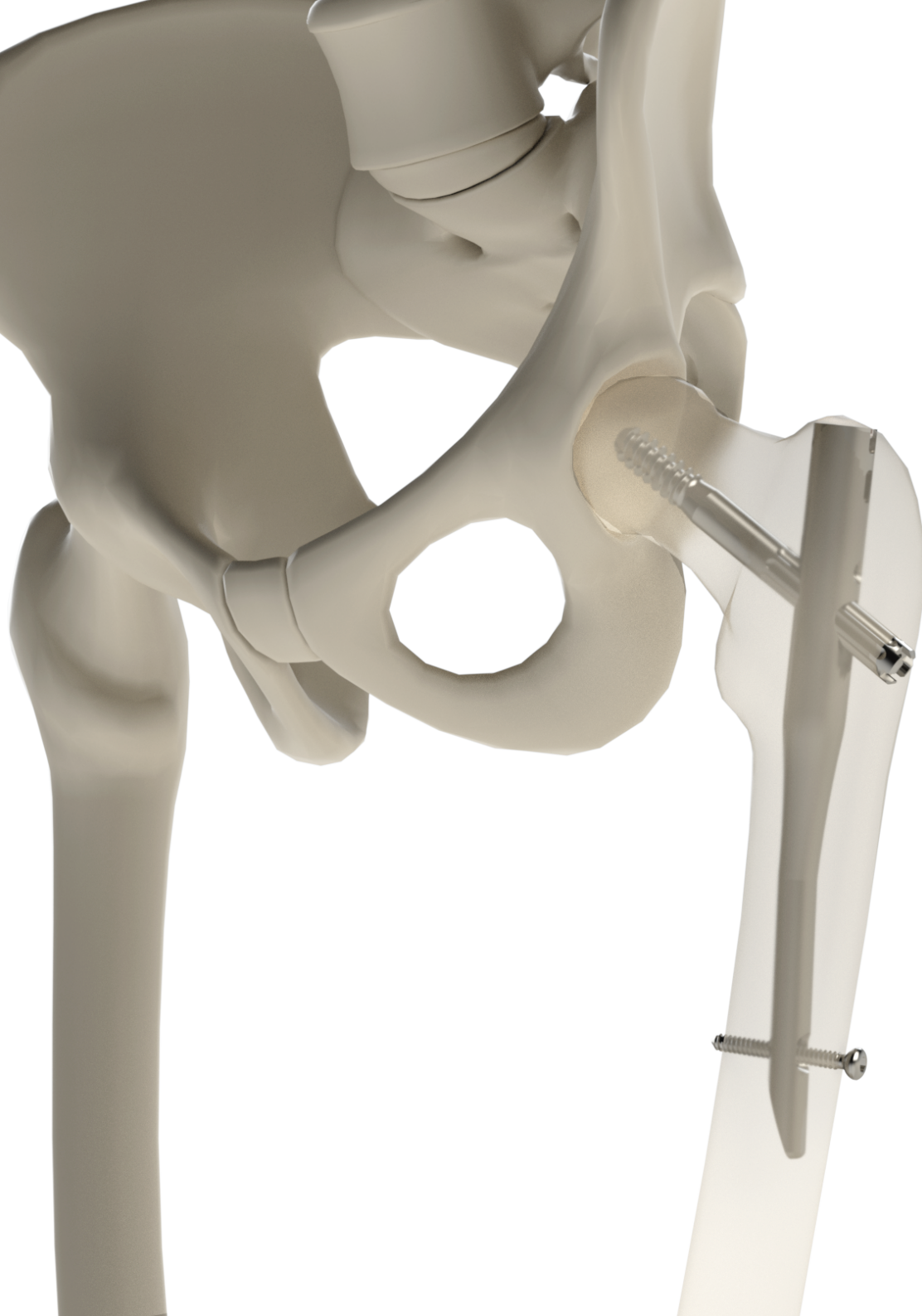

Lower Limb

Arto inferiore

SuperNail GT

Femoral nail Chiodo femorale



Standard femoral nail Chiodo femorale standard

Ti6Al4V

A Ø 15.5 mm

B Ø 10 mm

C 4°

D

L [mm]

HSJ 125-10 125° 180

HSJ 125-20 125° 205

HSJ 130-10 130° 180

HSJ 130-20 130° 205

Sterile single packaging.
Confezione singola sterile.

- A** Proximal diameter / Diametro prossimale
- B** Distal diameter / Diametro distale
- C** Bending angle / Angolo di curvatura
- D** CCD angle / Angolo CCD

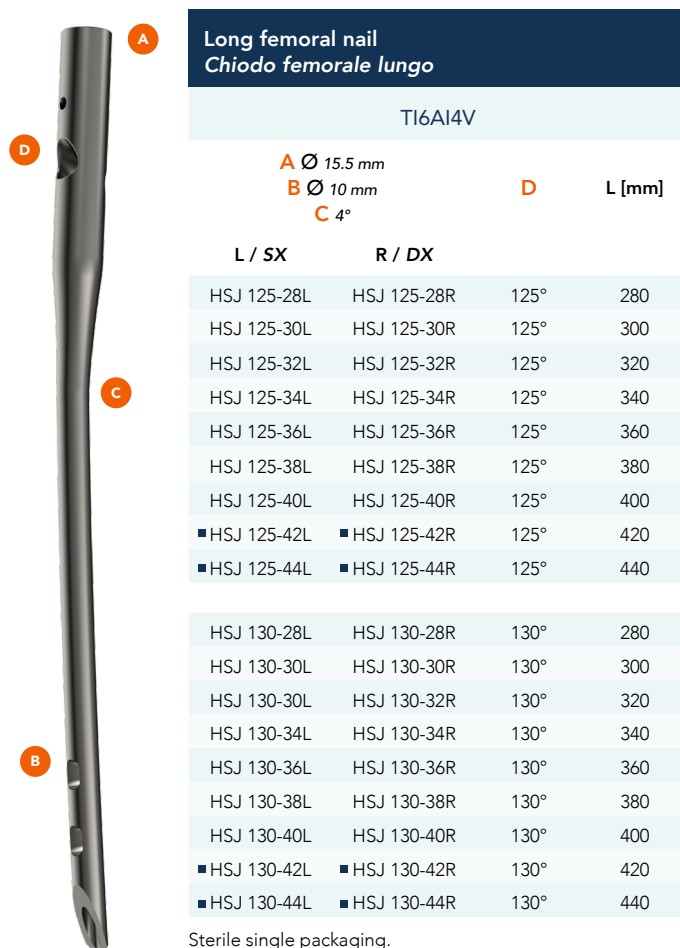

Long femoral nail Chiodo femorale lungo

Ti6Al4V

A Ø 15.5 mm

B Ø 10 mm

C 4°

D

L [mm]

L / SX **R / DX**

HSJ 125-28L HSJ 125-28R 125° 280

HSJ 125-30L HSJ 125-30R 125° 300

HSJ 125-32L HSJ 125-32R 125° 320

HSJ 125-34L HSJ 125-34R 125° 340

HSJ 125-36L HSJ 125-36R 125° 360

HSJ 125-38L HSJ 125-38R 125° 380

HSJ 125-40L HSJ 125-40R 125° 400

■ HSJ 125-42L ■ HSJ 125-42R 125° 420

■ HSJ 125-44L ■ HSJ 125-44R 125° 440

HSJ 130-28L HSJ 130-28R 130° 280

HSJ 130-30L HSJ 130-30R 130° 300

HSJ 130-30L HSJ 130-32R 130° 320

HSJ 130-34L HSJ 130-34R 130° 340

HSJ 130-36L HSJ 130-36R 130° 360

HSJ 130-38L HSJ 130-38R 130° 380

HSJ 130-40L HSJ 130-40R 130° 400

■ HSJ 130-42L ■ HSJ 130-42R 130° 420

■ HSJ 130-44L ■ HSJ 130-44R 130° 440

Sterile single packaging.
Confezione singola sterile.

- Upon request.
- Su richiesta.



Cephalic screw Vite cefalica

Ti6Al4V

A Ø 10.5 mm L [mm]

HSJ C270	70
HSJ C275	75
HSJ C280	80
HSJ C285	85
HSJ C290	90
HSJ C295	95
HSJ C300	100
HSJ C305	105
HSJ C310	110
HSJ C315	115
HSJ C320	120

Sterile single packaging.
Confezione singola sterile.

Hexagonal socket
Cava esagonale



Blocking screw Vite di bloccaggio

Ti6Al4V

C Ø 8 mm L [mm]

HSN B830	25
----------	----

Sterile single packaging.
Confezione singola sterile.



Distal screw Vite distale

Ti6Al4V

B Ø 4.5 mm L [mm]

HMV 108-024ST	24
HMV 108-028ST	28
HMV 108-032ST	32
HMV 108-036ST	36
HMV 108-040ST	40
HMV 108-044ST	44
HMV 108-048ST	48
HMV 108-052ST	52
HMV 108-056ST	56
HMV 108-060ST	60
HMV 108-064ST	64
HMV 108-068ST	68
HMV 108-072ST	72
HMV 108-076ST	76
HMV 108-080ST	80
HMV 108-084ST	84
HMV 108-088ST	88
HMV 108-092ST	92
HMV 108-096ST	96
HMV 108-100ST	100

Sterile single packaging.
Confezione singola sterile.

- A** Cephalic screw diameter / Diametro vite cefalica
- B** Distal screw diameter / Diametro vite distale
- C** Blocking screw diameter / Diametro vite di bloccaggio



Locking plug Tappo di chiusura

Ti6Al4V

Offset [mm]

HSN T001	0
HSN T003	+ 5
HSN T002	+ 15

Sterile single packaging.
Confezione singola sterile.

Instrument set for SuperNail GT standard Strumentario per SuperNail GT standard

HSJ 0200	Complete set	Set completo
1	HSJ 0006 Nail holder	Portachiodo
2	HSJ 0009 Centering device 125°	Mirino 125°
3	HSJ 0010 Centering device 130°	Mirino 130°
4	HSJ 0007 Serrating bolt (2 pcs.)	Bullone di serraggio (2 pz.)
5	HSN 0327 Assembly screwdriver	Cacciavite per assemblaggio
6	HSN 0256 Self-locking chuck	Mandrino autoserrante
7	HSJ 0001 Cannulated awl	Perforatore cannulato
8	HSJ 0001-1 Plugging device	Otturatore
9	HSJ 0003 Protector for soft tissues	Protettore per tessuti molli
10	HSJ 0004 Initial reamer	Fresa iniziale
11	HSJ 0005-1 Lever for straight handle	Leva per impugnatura retta
12	HSJ 0005 Quick connection straight handle	Impugnatura retta con attacco rapido
13	HSJ 0040 Quick connection T handle	Impugnatura a T con attacco rapido
14	HSN 0401 Connection device	Dispositivo di raccordo
15	HSJ 0012 Anti-rotation wire Ø 3 mm	Filo antirotazione Ø 3 mm
16	HSJ 0011 Sleeve for anti-rotation wire	Manicotto per filo antirotazione
17	HSJ 0038 Cephalic trocar	Trocar cefalico
18	HSJ 0039 Distal trocar	Trocar distale
19	HSJ 0013 External sleeve for cephalic screw	Manicotto esterno per vite cefalica
20	HSJ 0014 Internal sleeve for cephalic guide wire	Cannula interna per filo guida cefalico
21	HSJ 0015 Cephalic guide wire Ø 3.2 mm	Filo guida per vite cefalica Ø 3,2 mm
22	HSJ 0016 Measuring device for cephalic screw	Misuratore per vite cefalica
23	HSJ 0017 Cephalic reamer	Alesatore cefalico
24	HSJ 0029 Cephalic screwdriver	Cacciavite cefalico
25	HSJ 0025 Bush for distal fixation	Boccola per fissazione distale
26	HSJ 0026 Distal sleeve for standard nail	Manicotto distale per chiodo standard
27	HSJ 0027 Internal sleeve for drill bit Ø 3.5 mm	Cannula interna per punta Ø 3,5 mm
28	HSJ 0028 Drill bit Ø 3.5 mm	Punta Ø 3,5 mm
29	HSJ 0037 Measuring device for distal screws	Misuratore per viti distali
30	HSJ 0030 Screwdriver 3.5 mm for distal screws	Cacciavite 3,5 mm per viti distali
31	HSJ 0033 Flexible screwdriver	Cacciavite flessibile
32	HSJ 0024 Extraction connection	Raccordo di estrazione
33	HSN 0400 Extraction device	Dispositivo di estrazione
34	HSJ 0100 Tray	Vassoio

Instrument set for SuperNail GT standard Strumentario per SuperNail GT standard

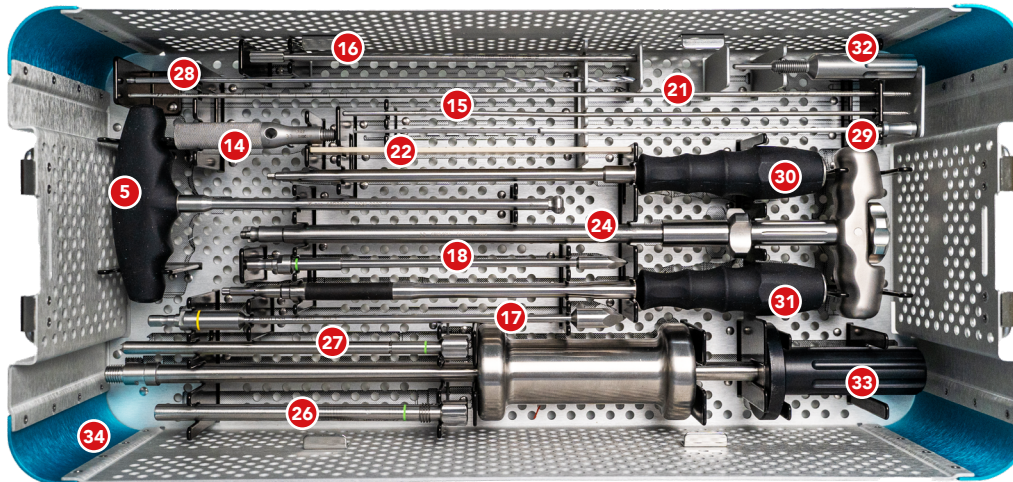
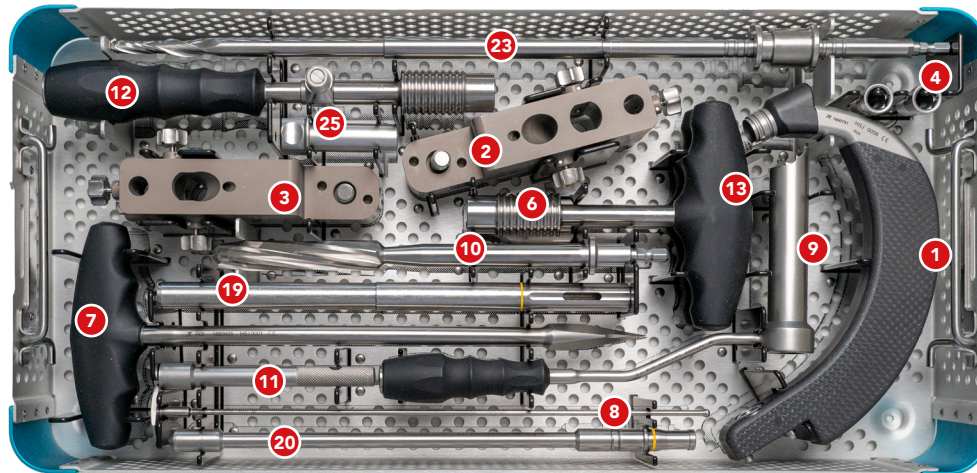

Guide wires smooth tip
Filo guida punta smussa

	Ø [mm]	L [mm]
HSJ 0002	3	800
HSJ 0002-100	3	1000

SuperNail GT

Instrument set for SuperNail GT long Strumentario per SuperNail GT lungo

HSJ 0300		Complete set	Set completo
1	HSN 0550-125	Centering device for long nail 125°	Mirino per chiodo lungo 125°
2	HSN 0550-130	Centering device for long nail 130°	Mirino per chiodo lungo 130°
3	HSJ 0041	Measuring device for long nail	Misuratore chiodo lungo
4	HSJ 0034	Guide wires exchange tube	Tube di scambio per fili guida
5	HSN 0232	Multihole guide	Guida multiforo
6	HSN 0420	Positioning pin Ø 2 mm for multihole guide (2 pcs.)	Pin di posizionamento per guida multiforo Ø 2 mm (2 pz.)
7	HSJ 0036	External sleeve for long nail	Manicotto distale per chiodo lungo
8	HSJ 0032	Cannulated tip Ø 3.5 mm	Punta cannulata Ø 3.5 mm
9	HSN 1600	Tray	Vassoio

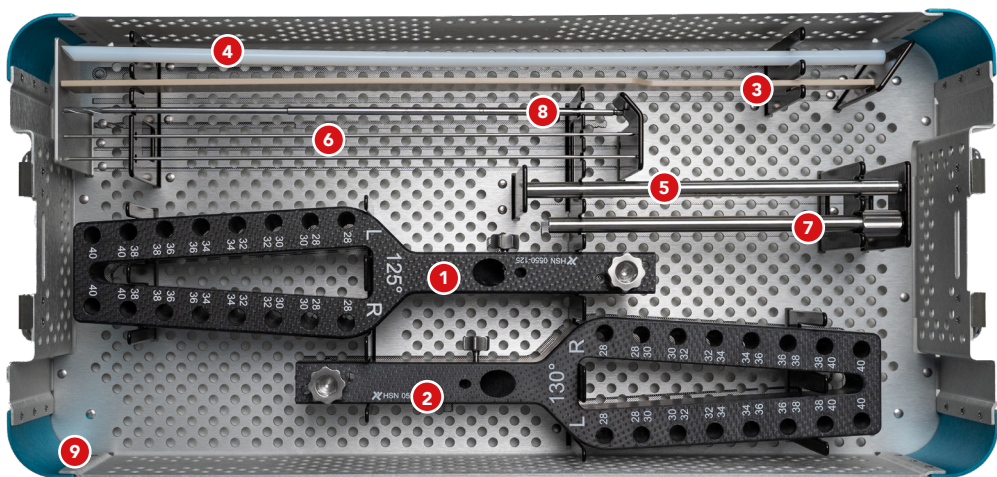

Guide wires olive tip
Filo guida punta oliva

	Ø [mm]	L [mm]
HSN 0235	3	800
HSN 0236	3	1000

Extraction instrument set Strumentario di estrazione

HSJ 0400		Complete set	Set completo
1	HSJ 0012	Anti-rotation wire Ø 3 mm	Filo antirotazione Ø 3 mm
2	HSJ 0024	Extraction connection	Raccordo di estrazione
3	HSJ 0029	Cephalic screwdriver	Cacciavite cefalico
4	HSJ 0030	Screwdriver 3.5 mm for distal screws	Cacciavite 3,5 mm per viti distali
5	HSN 0400	Extraction device	Dispositivo di estrazione
6	HSN 0215	Cardanic key	Chiave cardanica
7	HSN 0280	Screwdriver for blocking screw	Cacciavite per vite di bloccaggio
8	HSJ 0120	Tray	Vassoio

Extraction set for non-users
Strumentario di rimozione per non utilizzatori

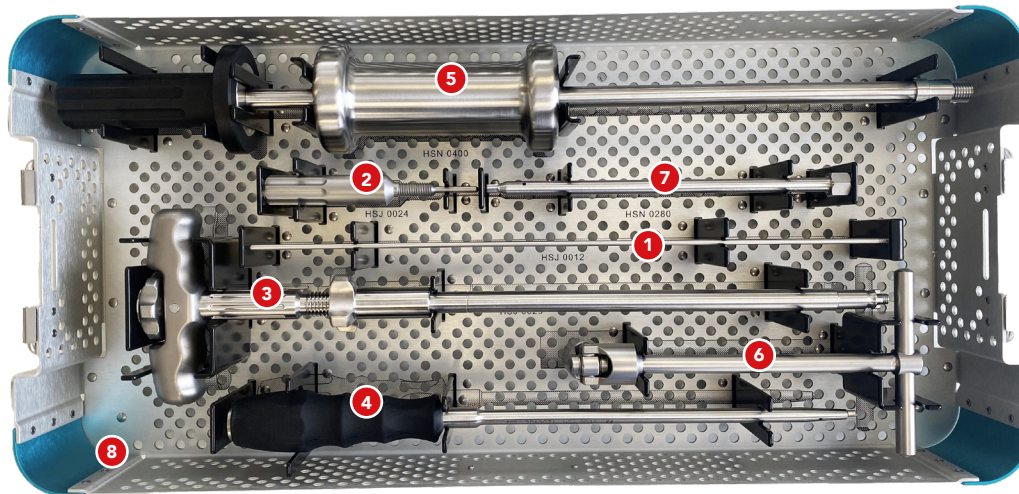

Universal extractor Estrattore universale

Universal extractor set for stems Set estrattore universale per steli

SU 240	Extractor body	Corpo estrattore
HSN 0400	Sliding hammer	Massa battente
HSN 0215	Cardanic key	Chiave cardanica



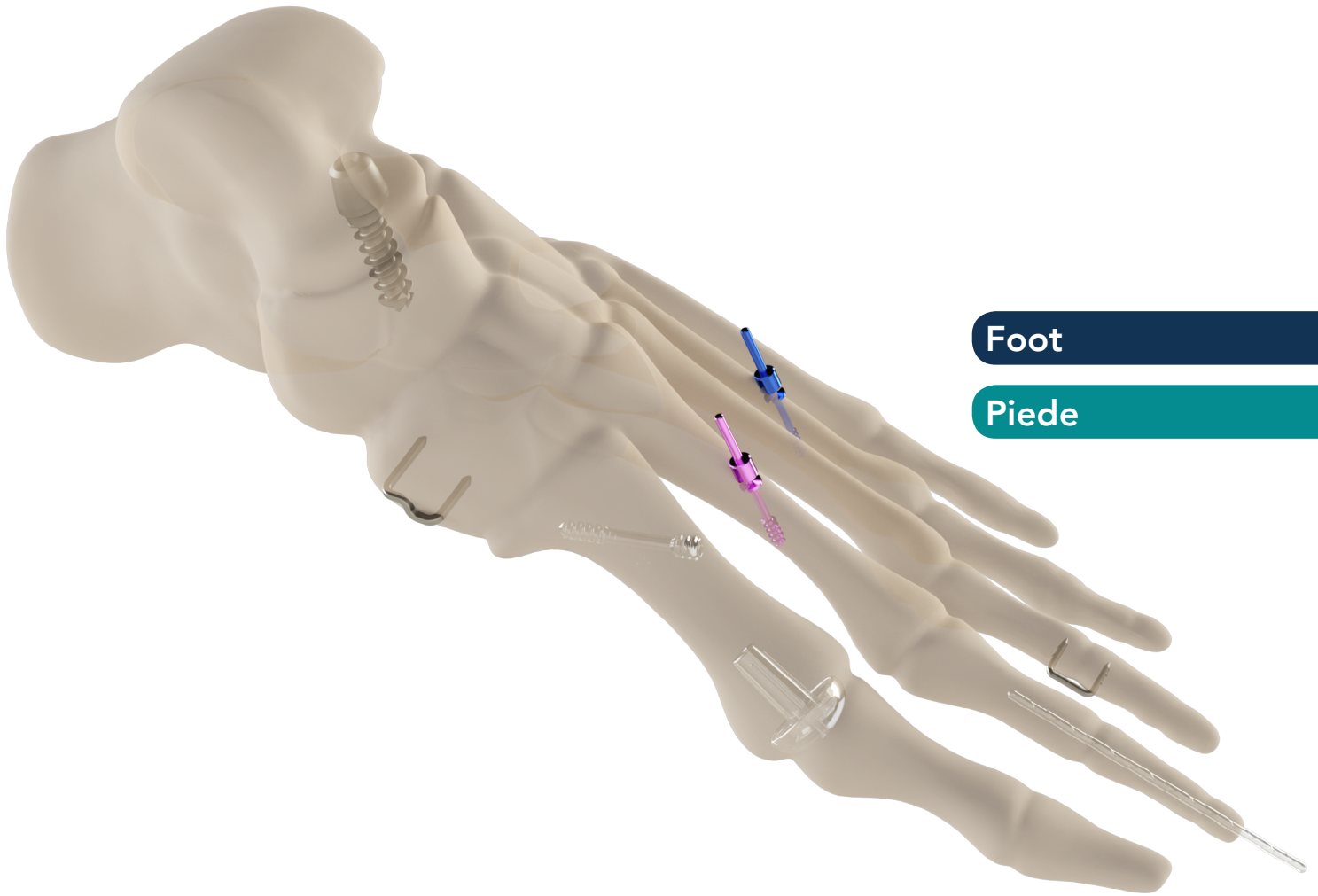

Foot

Piede

Minimally Invasive Foot Surgery Chirurgia mininvasiva del piede



Double threaded screw - total thread
Vite a doppia filettatura - filetto totale

Ti6Al4V		
	A Ø 4 mm; B Ø 3 mm	L [mm]
HMV 541-10ST		10
HMV 541-12ST		12
HMV 541-14ST		14
HMV 541-16ST		16
HMV 541-18ST		18
HMV 541-20ST		20
HMV 541-22ST		22
HMV 541-24ST		24
HMV 541-26ST		26
HMV 541-28ST		28
HMV 541-30ST		30
HMV 541-32ST		32
■ HMV 541-34ST		34
■ HMV 541-36ST		36
■ HMV 541-38ST		38
■ HMV 541-40ST		40
■ HMV 541-42ST		42
■ HMV 541-44ST		44
■ HMV 541-46ST		46
■ HMV 541-48ST		48
■ HMV 541-50ST		50

Sterile single packaging.
Confezione singola sterile.

A Head thread / Filetto di testa
B Tip thread / Filetto di punta

L_T Thread length / Lunghezza filetto



Double threaded screw - partial thread
Vite a doppia filettatura - filetto parziale

Ti6Al4V			
	A Ø 4.2 mm B Ø 3.2 mm	L [mm]	L _T [mm]
HMV 542-12ST		12	5
HMV 542-14ST		14	
HMV 542-16ST		16	7
HMV 542-18ST		18	
HMV 542-20ST		20	
HMV 542-22ST		22	9
HMV 542-24ST		24	
HMV 542-26ST		26	10
HMV 542-28ST		28	11
HMV 542-30ST		30	12
HMV 542-32ST		32	13
■ HMV 542-34ST		34	14
■ HMV 542-36ST		36	15
■ HMV 542-38ST		38	16
■ HMV 542-40ST		40	17
■ HMV 542-42ST		42	18
■ HMV 542-44ST		44	19
■ HMV 542-46ST		46	
■ HMV 542-48ST		48	21
■ HMV 542-50ST		50	

Sterile single packaging.
Confezione singola sterile.

■ Upon request.
■ Su richiesta.

Cannulated drill bits and guide wires
Punte cannulate e fili guida

LHV039-1	Guide wire <i>Filo guida</i>	Ø 1 mm; L. 100 mm
LHV040-1	Reduction wire <i>Filo di riduzione</i>	Ø 2 mm; L. 200 mm
LHV035L	Distal cannulated drill bit <i>Punta cannulata distale</i>	Ø 2 mm
LMI008L	Proximal cannulated drill bit <i>Punta cannulata prossimale</i>	Ø 3.2 mm

Sterile single packaging. Single use.
Confezione singola sterile. Monouso.

Burrs
Frese

1	LMI001-1	Shannon	Ø 2.2 mm; L. 20 mm
2	LMI002-1	Shannon	Ø 2.2 mm; L. 12 mm
3	LMI003-1	Shannon	Ø 2.2 mm; L. 8 mm
4	LMI004-1	Wedge / <i>A cuneo</i>	Ø 2.9 mm; L. 13 mm
5	LMI005-1	Wedge / <i>A cuneo</i>	Ø 4.3 mm; L. 13 mm
6	LMI007-1	Shannon	Ø 3 mm; L. 20 mm

Sterile single packaging. Single use.
Confezione singola sterile. Monouso.

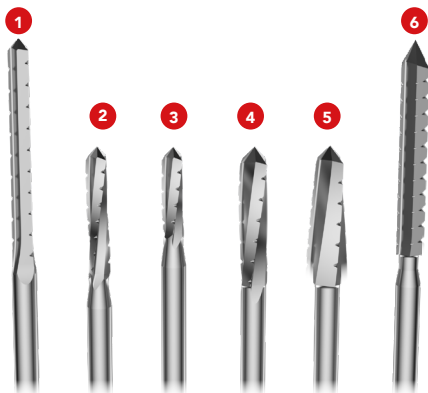

LMI100 Complete set
Set completo

1	MFS 090000	Box	
2	LMI 006-006	Measuring device / <i>Misuratore</i>	
3	LNSWG0007	Cannulated screwdriver <i>Cacciavite cannulato</i>	Ø 2 mm
4	LMI 006-002	Curved elevator / <i>Elevatore curvo</i>	
5	LMI 006-003	Straight elevator / <i>Elevatore retto</i>	
6	LMI 006-004	Rasp / <i>Raspa</i>	
7	LMI 006-001	Blade handle / <i>Porta lama</i>	
	5904*	Beaver blade (25 pcs.) / <i>Lama Beaver (25 pz.)</i>	

*Not included in the kit, to be ordered separately.
**Non incluso nel set, ordinare separatamente.*

Hegaxon
Esagon

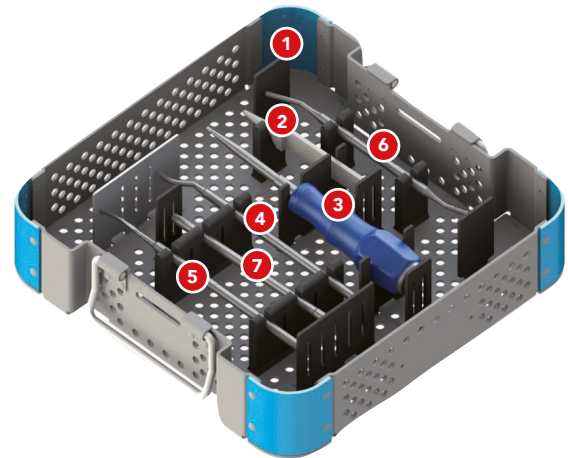

Equipments
Attrezzature

Y1003587	Burr machine	<i>Macchina motore</i>
SGS-ES	Straight handle	<i>Terminale dritto</i>
WG1000	Carry case	<i>Valigia</i>
SG70M	Motor cord	<i>Cavo motore</i>
NK0045002	Single use irrigation kit	<i>Dispositivo di irrigazione monouso</i>

SH - Screw

Cannulated screws with bevelled head Viti cannulate con testa obliqua

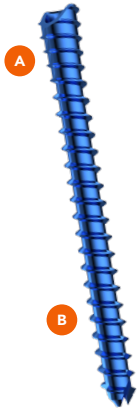

Cannulated conical threaded screw
Vite cannulate conica filettata

Ti6Al4V

A \varnothing 3.2 mm

B \varnothing 2.5 mm

L [mm]

HMV 250-010	10
HMV 250-011	11
HMV 250-012	12
HMV 250-013	13
HMV 250-014	14
HMV 250-016	16
HMV 250-018	18
HMV 250-020	20
HMV 250-022	22
HMV 250-024	24
HMV 250-026	26
HMV 250-028	28

Sterile single packaging.
Confezione singola sterile.



Cannulated double threaded screw
Vite cannulate a doppia filettatura

Ti6Al4V

A \varnothing 4 mm

B \varnothing 3 mm

L [mm]

L_T [mm]

HMV 251-016	16	6
HMV 251-018	18	7
HMV 251-020	20	8
HMV 251-022	22	9
HMV 251-024	24	10
HMV 251-026	26	10
HMV 251-028	28	10
HMV 251-030	30	10
HMV 251-032	32	10
HMV 251-034	34	10

Sterile single packaging.
Confezione singola sterile.

A Head thread / Filetto di testa

B Tip thread / Filetto di punta

L_T Thread length / Lunghezza filetto

Instrument Strumentario				
1	STR 060270			HMV 250
2	STR 060330	Proximal countersink *	Svasatore proximale *	HMV 251
3	STR 030151			HMV 250 Ø 1.5 mm
4	STR 030201	Cannulated screwdriver *	Cacciavite cannulato *	HMV 251 Ø 2 mm
5	STR 030150			HMV 250 Ø 1.5 mm
6	STR 030200	Solid screwdriver *	Cacciavite pieno *	HMV 251 Ø 2 mm
7	STR 13A129	Straight cannulated handle *	Impugnatura retta cannulata *	
8	HMV 311	Cannulated drill bit	Punta cannulata	Ø 2 mm
9	HME 353-02	Guide wire	Filo guida	Ø 1 mm; L. 155 mm
10	HMV 440-08	Guide wire (10 pcs.)	Filo guida (10 pz.)	Ø 0,8 mm; L. 155 mm
11	HME 353-01	Guide wire measuring device	Misuratore per filo guida	
12	HMV 106-000	Tray	Vassoio	

* AO coupling / Attacco AO

⊗ Hexagon / Esagono

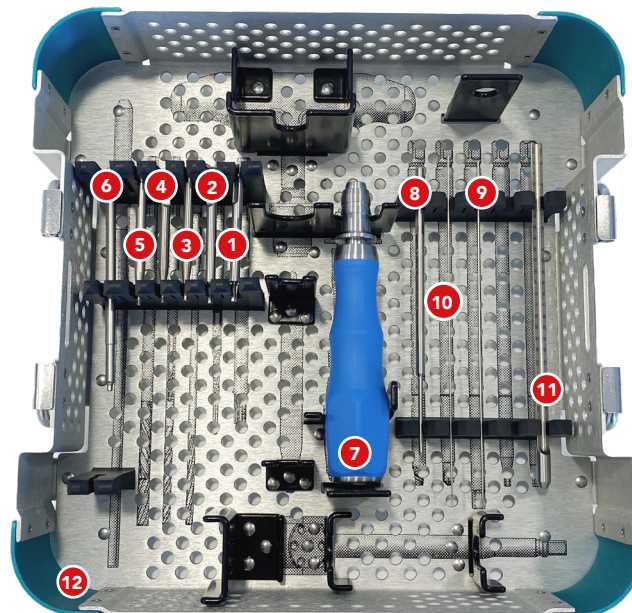

SG Metatarsal spacer

Resorbable spacer for metatarsophalangeal joints surgeries

Spaziatore riassorbibile per interventi dell'articolazione metatarso-falangea



SG Metatarsal spacer
Spaziatore metatarsale SG

PLLA

B \varnothing 5 mm

A \varnothing [mm]

MTF 800013

13

MTF 800016

16

Sterile single packaging.
Confezione singola sterile.

A Head diameter / Diametro di testa

B Tip diameter / Diametro di punta

Kirschner wire double trocar point
Filo di kirschner punta doppia trocar

AISI 316L ESR

\varnothing [mm]

L [mm]

HME 742-12

1.2

155

Non sterile single packaging, set of 10 pcs.
Confezione non sterile da 10 pz.



Instrument set Strumentario

1	MTF 060560	Perforator	Perforatore
2	MTF 071316	Impactor	Battitore

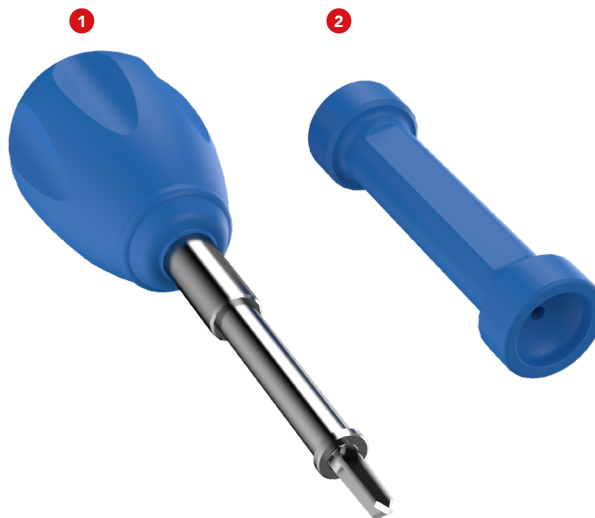

Resorbable implants for foot surgery Impianti riassorbibili per la chirurgia del piede

Triangular socket
Cava triangolare



A Head diameter / Diametro di testa
B Tip diameter / Diametro di punta

L_T Thread length / Lunghezza filetto

Resorbable double threaded screw
Vite a doppia filettatura riassorbibile

P(L/DL)LA 70/30

A Ø 4.3 mm
B Ø 3.3 mm
L_T 9 mm

	L [mm]
RSB 460-14	14
RSB 460-18	18
RSB 460-22	22
RSB 460-26	26
RSB 460-30	30

Sterile single packaging.
Confezione singola sterile.

RSB 400		Complete set Set completo	
1	HME 353-01	Measuring device Misuratore	
2	HME 353-02	Guide wire (2 pcs) Filo guida (2 pz)	Ø 1 mm L. 155 mm
3	RSB 461-25	Cannulated distal drill Punta distale cannulata	Ø 2.5 mm
4	RSB 030155	Triangle-shaped screwdriver * Cacciavite triangolare *	L. 1.5 mm
5	RSB 040045	Tap for head thread * Maschiatore per filetto di testa *	
6	STR 13A129	Straight cannulated handle * Impugnatura retta cannulata *	
7	RSB 040035	Tap for tip thread * Maschiatore per filetto di punta *	
8	STR 13D142	Torque limiting handle Impugnatura dinamometrica	
9	RSB 090010	Tray Vassoio	

* AO coupling / Attacco AO

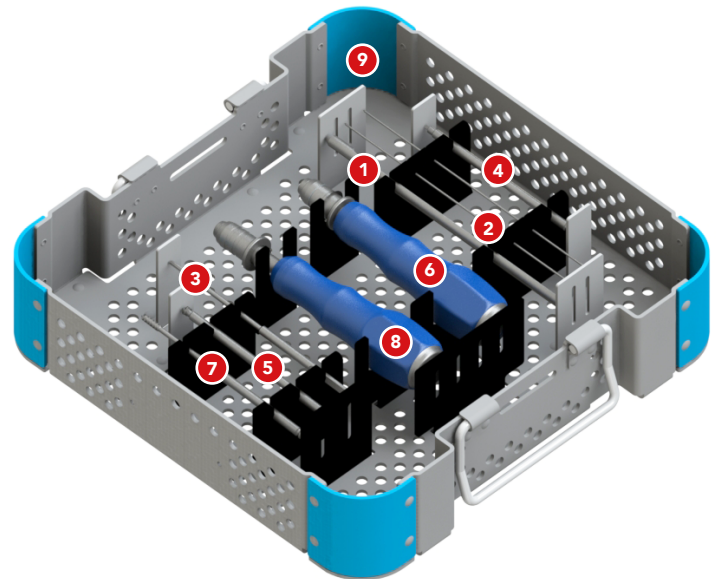

RSB Implants



Resorbable pin Pin riassorbibile

P(L/DL)LA 70/30

L 60 mm	Ø [mm]
RSB 018-60	1.8
RSB 025-60	2.4

Sterile single packaging.
Confezione singola sterile.

Helicoidal profile.
Profilo elicoidale.

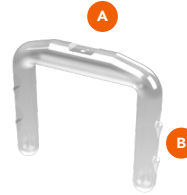
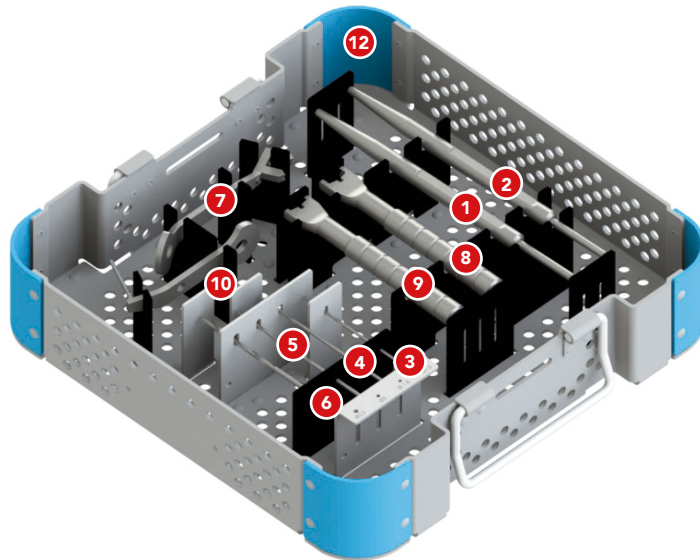

Resorbable staple Cambra riassorbibile

P(L/DL)LA 70/30

	Ø [mm]	A [mm]	B [mm]
RSB 200-12	2	12	10

Sterile single packaging.
Confezione singola sterile.

A Bridge width / Larghezza ponte
B Legs length / Lunghezza rebbi

RSB 100

Complete set Set completo

RSB 018-60/025-60

1	RSB 00100	Insert for pin Inseritore per pin	Ø 1.8 mm
2	RSB 00101	Insert for pin Inseritore per pin	Ø 2.4 mm
3	3600-015	Drill bit / Punta	Ø 1.5 mm
4	3600-018	Drill bit / Punta	Ø 1.8 mm
5	3600-020	Drill bit / Punta	Ø 2 mm
6	3600-025	Drill bit / Punta	Ø 2.5 mm

RSB 200-12

7	RSB 201	Drilling guide Guida di foratura	
8	RSB 202	Staple initial impactor Impattatore iniziale per cambra	
9	RSB 203	Staple final impactor Impattatore finale per cambra	
10	RSB 205	Staple expulsor Espulsore per cambra	
5	3600-020	Drill bit / Punta	Ø 2 mm
12	RSB 090020	Tray Vassoio	

Resorbable screw for the treatment of pediatric flat (pronated) foot Vite riassorbibile per il trattamento del piede piatto (pronato) pediatrico

Square socket
Cava quadrata



Cannulated screw
Vite cannulata

PLLA

A Ø 11 mm
B Ø 9 mm
H 6.5 mm

L [mm]

RSB 718 18

RSB 723 23

Sterile single packaging.
Confezione singola sterile.

Square socket
Cava quadrata



Solid screw
Vite piena

PLLA

A Ø 10 mm
B Ø 7 mm
H 6.5 mm

L [mm]

RSB 618 18

Sterile single packaging.
Confezione singola sterile.

A Head diameter / Diametro di testa

B Tip diameter / Diametro di punta

H Head height / Altezza testa

RSB 600		Complete set Set completo	
1	RSB 060550	Awl Perforatore	
2	RSB 030330	Cannulated screwdriver Cacciavite cannulato	L. 3.5 mm
3	RSB 040090	Cannulated tap * Maschiatore cannulato *	Ø 9 mm
4	RSB 040070	Tap * Maschiatore *	Ø 7 mm
5	STR 150010	Cannulated "T" handle * Impugnatura a "T" cannulata *	
6	RSB 605	Cannulated drill bit Punta cannulata	Ø 6 mm
7	RSB 606	Guide wire (2 pcs) Filo guida (2 pz.)	Ø 2 mm
8	RSB 090000	Tray Vassoio	

* AO coupling / Attacco AO

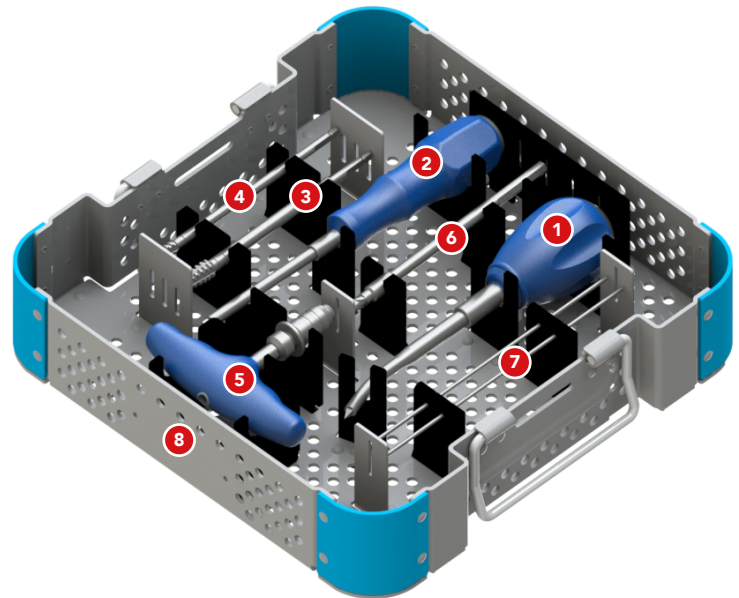

Self-breaking screws Viti autorompenti

Ti6Al4V

A \varnothing 2 mm **L** [mm] **L_T** [mm]

HMV 390-07-1ST	7	3.5
HMV 390-09-1ST	9	5.5
HMV 390-10-1ST	10	6.5
HMV 390-11-1ST	11	7
HMV 390-12-1ST	12	
HMV 390-13-1ST	13	8
HMV 390-14-1ST	14	
HMV 390-15-1ST	15	9
HMV 390-17-1ST	17	
HMV 390-19-1ST	19	11

A \varnothing 2.7 mm

HMV 395-11-1ST	11	7
HMV 395-12-1ST	12	
HMV 395-13-1ST	13	
HMV 395-14-1ST	14	8
HMV 395-15-1ST	15	
HMV 395-16-1ST	16	
HMV 395-17-1ST	17	9
HMV 395-18-1ST	18	10
HMV 395-19-1ST	19	11
HMV 395-20-1ST	20	12
HMV 395-22-1ST	22	13

Sterile single packaging.
Confezione singola sterile.

Instrument set Strumentario

HMV 392

Screwdriver

Cacciavite

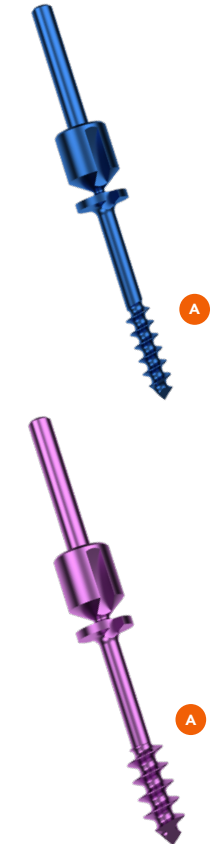

A Tip diameter / Diametro di punta

L_T Thread length / Lunghezza filetto

Serrated staples Cambra dentate

Serrated STRAIGHT staple Cambra dentata DRITTA

AISI 316L ESR



	A [mm]	B [mm]
HMA 245-40ST	7.5	7.8
HMA 245-41ST	10	7.8
HMA 245-42ST	10	9.8
HMA 245-43ST	12.5	7.8

Sterile single packaging.
Confezione singola sterile.

A Leg width / Larghezza rebbi

B Leg height/ Altezza rebbi

C Leg height in case of asymmetry / Altezza rebbi in caso di asimmetria

Serrated STRAIGHT ASYMMETRIC staple Cambra dentata DRITTA ASSIMETRICA

AISI 316L ESR



	A [mm]	B [mm]	C [mm]
HMA 250ST	10	8.1	10.2

Sterile single packaging.
Confezione singola sterile.

Serrated OBLIQUE staple Cambra dentata OBLIQUA

AISI 316L ESR

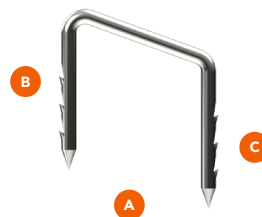

	A [mm]	B [mm]	C [mm]
HMA 251-08ST	7.5	11	11
HMA 251-10ST	10	11	11

Sterile single packaging.
Confezione singola sterile.

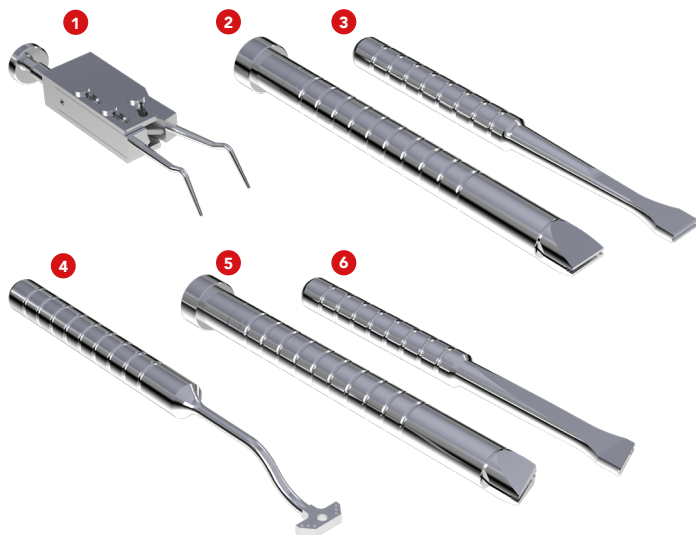

Instrument set Strumentario

1	HMA 246-1	Compressor Compressore
2	HMA 246-2	Staple holder impactor for straight staple Impattatore porta cambra per cambra dritta
3	HMA 246-3	Final impactor for straight staple Impattatore finale per cambra dritta
4	HMA 246-4	Guide mask Mascherina guida
5	HMA 246-5	Final impactor for oblique staple Impattatore finale per cambra obliqua
6	HMA 246-6	Staple holder impactor for oblique stable Impattatore porta cambra per cambra obliqua

Titanium calcaneo stop screw

Cannulated self-drilling and self-tapping eccentric screw for calcaneo stop Vite eccentrica cannulata autoproforante e autofilettante per calcaneo stop



Titanium calcaneo stop screw
Vite calcaneo stop in titanio

Ti6Al4V

A \varnothing 7 mm

B \varnothing 2.2 mm

L [mm]

HMV 445-28ST

28

HMV 445-32ST

32

HMV 445-36ST

36

Sterile single packaging.
Confezione singola sterile.



B

A Tip diameter / Diametro di punta

B Cannulation / Cannulazione

Instrument Strumentario			
1	HMV 353-04	Threaded guide wire Filo guida filettato	\varnothing 2 mm L. 230 mm
2	HMV 650-000	Cannulated drill bit Punta cannulata	\varnothing 4.5 mm
3	STR 031350	Cannulated screwdriver * Cacciavite cannulato *	\varnothing 3.5 mm
4	STR 13R127	Cannulated straight handle * Impugnatura retta cannulata *	
5	HM 00110	Measuring device Misuratore	
6	HMV 106-000	Tray Vassoio	

* 1/4" coupling / Attacco 1/4"

Hegaxon
Esagono

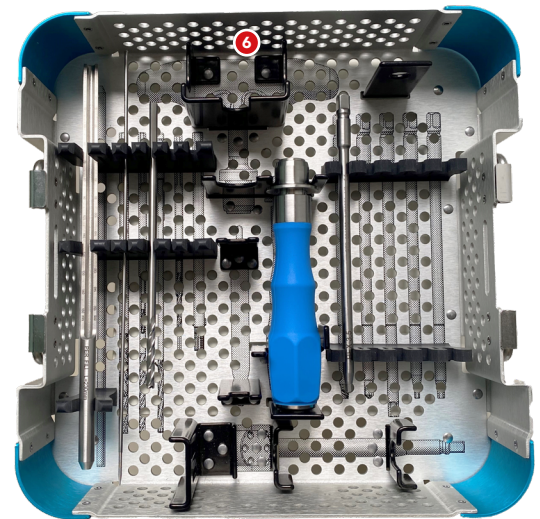
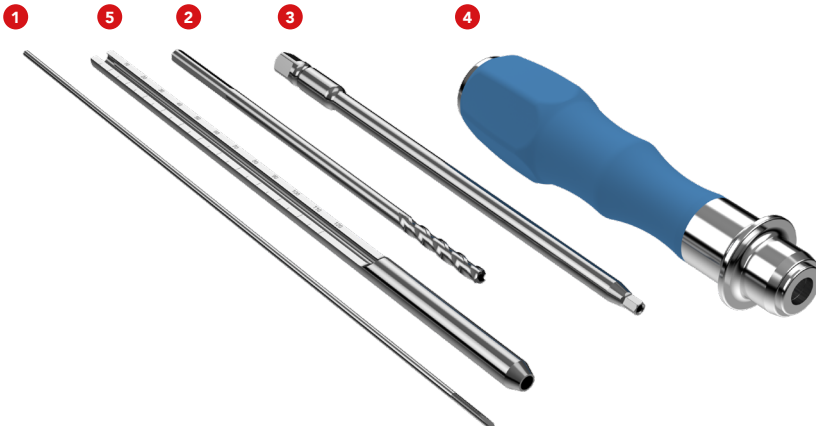

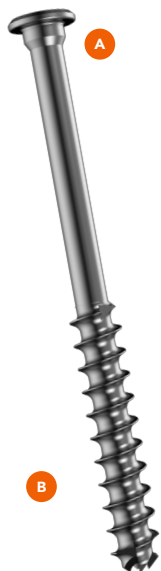

Flat head cannulated screw
Vite a testa piatta cannulata

Ti6Al4V

A Ø 8 mm
B Ø 6 mm

L [mm] L_T [mm]

HMV 220-025ST	25	
HMV 220-030ST	30	15
HMV 220-035ST	35	
HMV 220-040ST	40	
HMV 220-045ST	45	22
HMV 220-050ST	50	
HMV 220-055ST	55	
HMV 220-060ST	60	
HMV 220-065ST	65	
HMV 220-070ST	70	
HMV 220-075ST	75	
HMV 220-080ST	80	
HMV 220-085ST	85	
HMV 220-090ST	90	32
HMV 220-095ST	95	
HMV 220-100ST	100	
HMV 220-105ST	105	
HMV 220-110ST	110	
HMV 220-115ST	115	
HMV 220-120ST	120	

Sterile single packaging.
Confezione singola sterile.

A Head diameter
Diametro di testa
B Tip diameter
Diametro di punta

L_T Thread length
Lunghezza filetto



Flat head cannulated screw
Vite a testa piatta cannulata

Ti6Al4V

A Ø 8 mm
B Ø 4.5 mm

L [mm] L_T [mm]

HMV 221-020ST	20	
HMV 221-022ST	22	15
HMV 221-024ST	24	
HMV 221-026ST	26	
HMV 221-028ST	28	
HMV 221-030ST	30	
HMV 221-032ST	32	
HMV 221-034ST	34	20
HMV 221-036ST	36	
HMV 221-038ST	38	
HMV 221-040ST	40	
HMV 221-042ST	42	
HMV 221-044ST	44	
HMV 221-046ST	46	
HMV 221-048ST	48	25
HMV 221-050ST	50	
HMV 221-055ST	55	
HMV 221-060ST	60	30
HMV 221-065ST	65	
HMV 221-070ST	70	

Sterile single packaging.
Confezione singola sterile.



C External diameter / Diametro esterno
D Internal diameter / Diametro interno

Washer
Rondella

Ti6Al4V

D Ø 6.7 mm C Ø [mm]

HMV 356ST	13
HMV 355ST	16
HMV 354ST	19

Sterile single packaging.
Confezione singola sterile.

Flat head screws

Viti a testa piatta

Instrument Strumentario			
1	HMV 353-04	Threaded guide wire for Ø 6 mm screws <i>Filo guida filettato per viti Ø 6 mm</i>	Ø 2 mm L. 230 mm
2	HMV 353-05	Threaded guide wire for Ø 4.5 mm screws <i>Filo guida filettato per viti Ø 4,5 mm</i>	Ø 1.6 mm L. 230 mm
3	STR 031350	Cannulated screwdriver * <i>Cacciavite cannulato *</i>	Ø 3.5 mm
4	STR 13R127	Cannulated straight handle * <i>Impugnatura retta cannulata *</i>	
5	STR 06050B	Cannulated countersink * <i>Frangicorticale cannulato *</i>	
6	STR 150020	Cannulated T handle * <i>Impugnatura a T cannulata *</i>	
7	HM 00110	Measuring device <i>Misuratore</i>	
8	HMV 106-000	Tray <i>Vassoio</i>	

* 1/4" coupling / Attacco 1/4"

∅ Hegaxon
Esagono

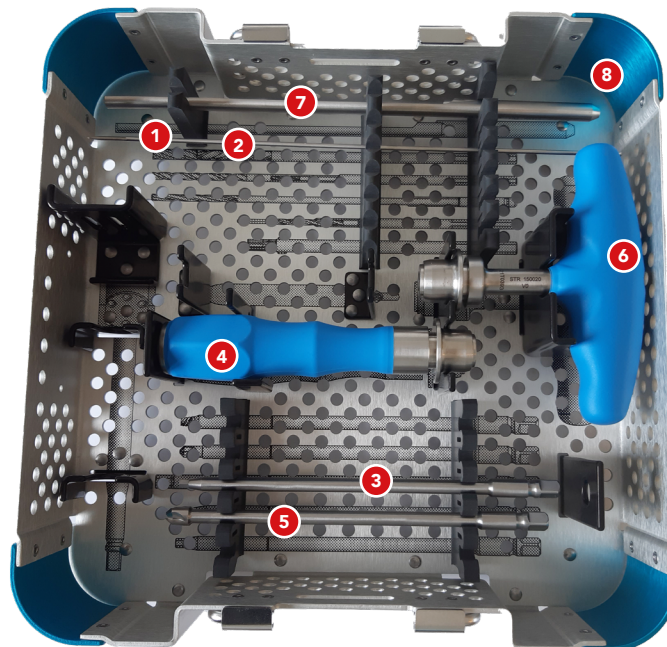

Cannulated double threaded screws Viti a doppia filettatura cannulate



DTS screw self-tapping Vite DTS autofilettante

Ti6Al4V

	A Ø 4 mm	B Ø 3 mm	L [mm]	L _T [mm]
HMV 410-12ST			12	5
HMV 410-14ST			14	
HMV 410-16ST			16	
HMV 410-18ST			18	6
HMV 410-20ST			20	
HMV 410-22ST			22	
HMV 410-24ST			24	
HMV 410-26ST			26	
HMV 410-28ST			28	
HMV 410-30ST			30	

Sterile single packaging with a \varnothing 0.8 mm guide wire.
Confezione singola sterile con filo guida \varnothing 0,8 mm.



DTS screw self-tapping Vite DTS autofilettante

Ti6Al4V

	A Ø 4 mm	B Ø 3 mm	L [mm]
			L _T 5 mm
HMV 430-12ST			12
HMV 430-14ST			14
HMV 430-16ST			16
HMV 430-18ST			18
HMV 430-20ST			20
HMV 430-22ST			22
HMV 430-24ST			24
HMV 430-26ST			26
HMV 430-28ST			28
HMV 430-30ST			30

Sterile single packaging with a \varnothing 0.8 mm guide wire.
Confezione singola sterile con filo guida \varnothing 0,8 mm.

- A Head diameter
Diametro di testa
B Tip diameter
Diametro di punta

L_T Thread length
Lunghezza filetto

Instrument set for DTS screw Ø 3 mm Strumentario per vite DTS Ø 3 mm

STR 031180	Cannulated screwdriver * Cacciavite cannolato *	Ø 1.8 mm
STR 13R127	Cannulated straight handle * Impugnatura retta cannolata *	
HMV 412-1	Cannulated drill bit Punta cannolata	Ø 2 mm
HMV 420	Guide wire (50 pcs.) Filo guida (50 pz.)	Ø 0.8 mm L. 155 mm
HMV 353-61	Double guide for wire and drill bit Guida doppia per filo e punta	
HME 353-01	Guide wire measuring device Misuratore per filo guida	
HMV 106-000	Tray Vassoio	

* 1/4" coupling / Attacco 1/4"

 Hegaxon
Esagono



- A** Head diameter
Diametro di testa
- B** Tip diameter
Diametro di punta
- L_T** Thread length
Lunghezza filetto

DTS screw self-tapping Vite DTS autofilettante

TI6Al4V	
A Ø 4.5 mm B Ø 3.5 mm L _T 8.5 mm	L [mm]
HMV 411-18ST	18
HMV 411-20ST	20
HMV 411-22ST	22
HMV 411-24ST	24
HMV 411-26ST	26
HMV 411-28ST	28
HMV 411-30ST	30
HMV 411-32ST	32
HMV 411-34ST	34
HMV 411-36ST	36
HMV 411-38ST	38
HMV 411-40ST	40

Sterile single packaging with a \varnothing 0.8 mm guide wire.
Confezione singola sterile con filo guida \varnothing 0,8 mm.



DTS screw self-drilling and self-tapping Vite DTS autop perforante e autofilettante

TI6Al4V	
A Ø 6 mm B Ø 4.5 mm L _T 12.5 mm	L [mm]
HMV 451-030ST	30
HMV 451-035ST	35
HMV 451-040ST	40
HMV 451-045ST	45
HMV 451-050ST	50
HMV 451-055ST	55
HMV 451-060ST	60
HMV 451-065ST	65
HMV 451-070ST	70

Sterile single packaging.
Confezione singola sterile.

Instrument set for DTS screw Ø 3.5 mm Strumentario per vite DTS Ø 3,5 mm

STR 031250	Cannulated screwdriver * Cacciavite cannulato *	Ø 2.5 mm
STR 13R127	Cannulated straight handle Impugnatura retta cannulata	
HMV 413-1	Cannulated drill bit Punta cannulata	Ø 2.7 mm
HMV 420	Guide wire (50 pcs.) Filo guida (50 pz.)	Ø 0.8 mm L. 155 mm
HME 353-01	Guide wire measuring device Misuratore per filo guida	
HMV 106-000	Tray Vassoio	

* 1/4" coupling / Attacco 1/4"

Esagono
Esagono

Instrument set for DTS screw Ø 4.5 mm Strumentario per vite DTS Ø 4,5 mm

STR 031250	Cannulated screwdriver * Cacciavite cannulato *	Ø 2.5 mm
STR 13R127	Cannulated straight handle Impugnatura retta cannulata	
HMV 450-002	Cannulated proximal reamer Fresa prossimale cannulata	Ø 4 mm
HMV 450-000	Cannulated distal reamer Fresa distale cannulata	Ø 3.2 mm
HMV 115-2	Guide wire Filo guida	Ø 1.5 mm L. 230 mm
HM 00110	Guide wire measuring device Misuratore per filo guida	
HMV 450-001	Cannulated tap Maschiatore cannulato	
HMV 106-000	Tray Vassoio	

* 1/4" coupling / Attacco 1/4"

Esagono
Esagono



- A** Head diameter
Diametro di testa
- B** Tip diameter
Diametro di punta
- L_T** Thread length
Lunghezza filetto

DTS screw self-drilling and self-tapping Vite DTS auto perforante e autofilettante

Ti6Al4V

A Ø 8 mm

B Ø 6.5 mm;

L_T 12.5 mm

L [mm]

HMV 651-040ST	40
HMV 651-045ST	45
HMV 651-050ST	50
HMV 651-055ST	55
HMV 651-060ST	60
HMV 651-065ST	65
HMV 651-070ST	70
HMV 651-075ST	75
HMV 651-080ST	80
HMV 651-085ST	85
HMV 651-090ST	90
HMV 651-095ST	95
HMV 651-100ST	100

Sterile single packaging.
Confezione singola sterile.

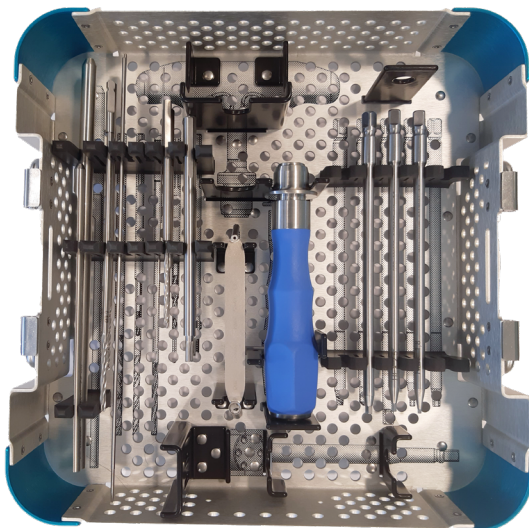

Instrument set for DTS screw Ø 6.5 mm Strumentario per vite DTS Ø 6,5 mm

STR 031350	Cannulated screwdriver * Cacciavite cannulato *	Ø 3.5 mm
STR 13R127	Cannulated straight handle Impugnatura retta cannulata	
HMV 650-002	Cannulated proximal reamer Fresa prossimale cannulata	Ø 5.5 mm
HMV 650-000	Cannulated distal reamer Fresa distale cannulata	Ø 4.5 mm
HMV 353-04	Threaded guide wire Filo guida filettato	Ø 2 mm . 230 mm
HMV 650-001	Cannulated tap Maschiatore cannulato	
HM 00110	Guide wire measuring device Misuratore per filo guida	
HMV 106-000	Tray Vassoio	

* 1/4" coupling / Attacco 1/4"

 Hexagon
Esagono

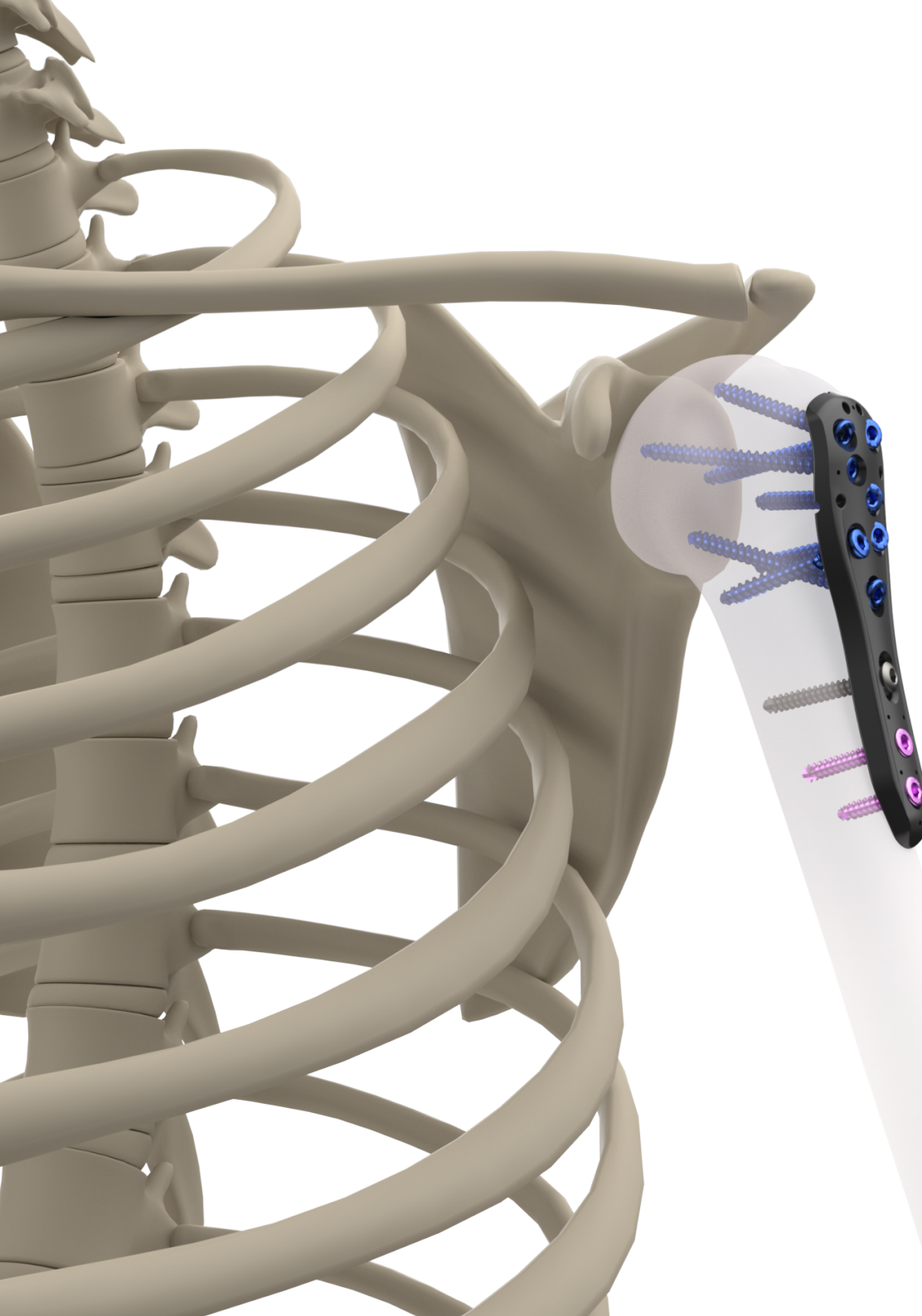

Upper limb

Arto superiore

DiPHOS H

Humeral plate Placca omerale



DiPHOS H plate Placca DiPHOS H

CFR PEEK 30%

Holes/Fori

8710.02.003	3
8710.02.005	5

Sterile single packaging.
Confezione singola sterile.

* Threaded head
Testa filettata

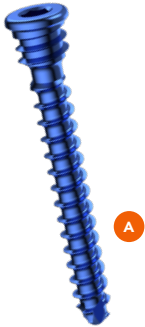

Cancellous screw Viti da spongiosa

Ti6Al4V

A Ø 4 mm **L** [mm]

8910.15.030.S	30
8910.15.032.S	32
8910.15.034.S	34
8910.15.036.S	36
8910.15.038.S	38
8910.15.040.S	40
8910.15.042.S	42
8910.15.044.S	44
8910.15.046.S	46
8910.15.048.S	48
8910.15.050.S	50
8910.15.055.S	55
8910.15.060.S	60

Sterile single packaging.
Confezione singola sterile.

* Threaded head
Testa filettata



Cortical screw Viti da corticale

Ti6Al4V

A Ø 3.5 mm **L** [mm]

8920.15.016.S	16
8920.15.018.S	18
8920.15.020.S	20
8920.15.022.S	22
8920.15.024.S	24
8920.15.026.S	26
8920.15.028.S	28
8920.15.030.S	30
8920.15.032.S	32
8920.15.034.S	34
8920.15.036.S	36
8920.15.038.S	38
8920.15.040.S	40

Sterile single packaging.
Confezione singola sterile.

A Tip diameter / Diametro di punta

L Length with screw head / Lunghezza con la testa della vite



A

Cortical screw spherical head
Viti da corticale con testa sferica

Ti6Al4V

A Ø 3.5 mm	L [mm]
8930.15.016.S	16
8930.15.018.S	18
8930.15.020.S	20
8930.15.022.S	22
8930.15.024.S	24
8930.15.026.S	26
8930.15.028.S	28
8930.15.030.S	30
8930.15.032.S	32
8930.15.034.S	34
8930.15.036.S	36
8930.15.038.S	38
8930.15.040.S	40

Sterile single packaging.
Confezione singola sterile.

A Tip diameter / *Diámetro di punta*

9087.10.000		
1	9087.10.010	Measuring device <i>Misuratore di profondità</i>
2	9087.10.020	Hexagonal screwdriver <i>Cacciavite esagonale</i> Ø 2.5 mm
3	9087.10.021	Hexagonal screwdriver * <i>Terminale esagonale *</i> Ø 2.5 mm
4	9087.10.031	Double drilling guide <i>Guida di foratura doppia</i> Ø 2.7 mm
5	9087.10.033	Handle for mask <i>Manico per maschera</i>
6	9087.10.034	Guide wire (10 pcs) <i>Filo guida (10 pz)</i> Ø 1.5 mm L. 155 mm
7	9087.10.035	Alignment mask for screws <i>Maschera per guida viti</i>
8	9087.10.036	Sleeve for screws <i>Manicotto per viti</i> Ø 6 mm
9	9087.10.037	Sleeve for drill Ø 2.7 mm <i>Manicotto per punta Ø 2.7 mm</i>
10	9087.10.038	Depth gauge for proximal holes <i>Misuratore di profondità per fori prossimali</i>
11	9087.10.040	Long drill bit (2 pcs) * <i>Punta lunga (2 pz) *</i> Ø 2.7 mm
12	9087.10.103	Trial plate <i>Placca di prova</i> 3 holes 3 fori
13	9087.10.105	Trial Plate <i>Placca di prova</i> 5 holes 5 fori
14	9087.10.990	Tray <i>Vassoio</i>

* Small AO coupling / *Attacco piccolo AO*

Ø Hexagon / *Esagono*

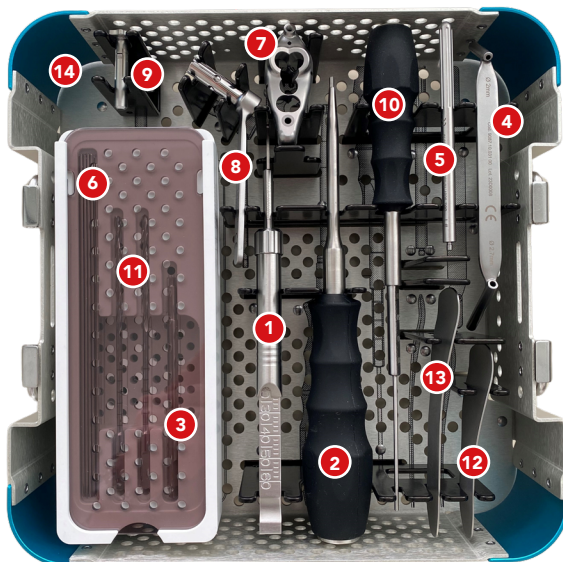

DiPHOS Nail

Humeral nail Chiodo omerale



Short nail Chiodo corto

Ti6Al4V+CFR PEEK 30%

A \varnothing 11 mm
B \varnothing 5.5 mm
C 6°

L / SX	R / DX	L [mm]
8730.15.100	8730.15.101	150

Sterile single packaging.
Confezione singola sterile.

- A Proximal diameter / Diametro prossimale
- B Distal diameter / Diametro distale
- C Bending angle / Angolo di curvatura



Long nail Chiodo lungo

Ti6Al4V+CFR PEEK 30%

A \varnothing 11 mm
C 6°

L / SX	R / DX	B \varnothing [mm]	L [mm]
8730.15.002	8730.15.008	7	200
8730.15.003	8730.15.009	7	220
8730.15.004	8730.15.010	7	240
8730.15.005	8730.15.011	7	260
8730.15.006	8730.15.012	7	280
8730.15.007	8730.15.013	7	300
8730.15.014	8730.15.020	8	200
8730.15.015	8730.15.021	8	220
8730.15.016	8730.15.022	8	240
8730.15.017	8730.15.023	8	260
8730.15.018	8730.15.024	8	280
8730.15.019	8730.15.025	8	300

Sterile single packaging.
Confezione singola sterile.



Proximal cancellous screws Vite prossimale da spongiosa

Ti6Al4V

A Ø 4.5 mm	L [mm]
8990.15.250.S	25
8990.15.275.S	27.5
8990.15.300.S	30
8990.15.325.S	32.5
8990.15.350.S	35
8990.15.375.S	37.5
8990.15.400.S	40
8990.15.425.S	42.5
8990.15.450.S	45
8990.15.475.S	47.5
8990.15.500.S	50
8990.15.525.S	52.5
8990.15.550.S	55
8990.15.575.S	57.5
8990.15.600.S	60

Sterile single packaging.
Confezione singola sterile.

A Tip diameter / Diametro di punta



Distal cortical screw Vite distale da corticale

Ti6Al4V

A Ø 3.5 mm	L [mm]
8980.15.018.S	18
8980.15.020.S	20
8980.15.022.S	22
8980.15.024.S	24
8980.15.026.S	26
8980.15.028.S	28
8980.15.030.S	30
8980.15.032.S	32
8980.15.034.S	34
8980.15.036.S	36
8980.15.038.S	38
8980.15.040.S	40

Sterile single packaging.
Confezione singola sterile.



Locking plug Tappo di chiusura

Ti6Al4V

	Offset [mm]
8731.15.100	0
8731.15.101	+ 2
8731.15.102	+ 4

Sterile single packaging.
Confezione singola sterile.

DiPHOS Nail

Instrument set Strumentario

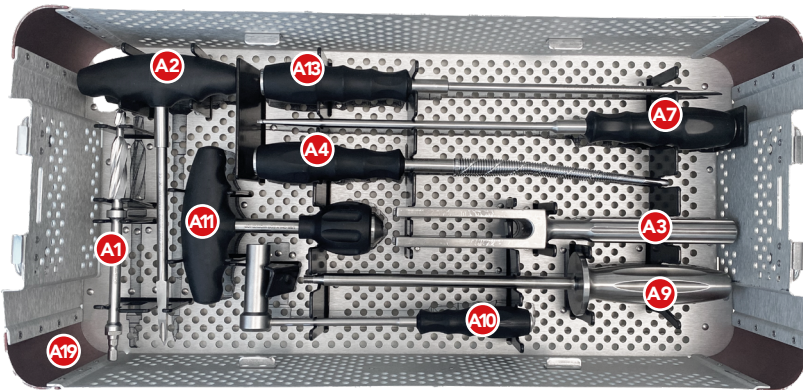
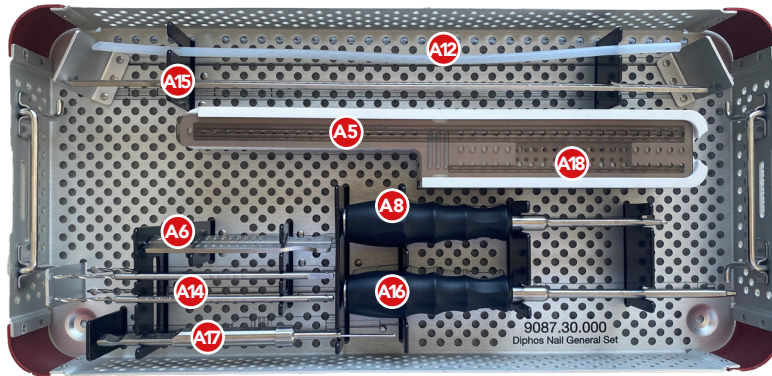

9087.30.000		General set	
A1	9087.30.001	Initial reamer	Fresa iniziale
A2	9087.30.002	Cannulated awl	Perforatore cannulato
A3	9087.30.004	Diapason hammer	Martello diapason
A4	9087.30.005	Rasp	Raspa
A5	9087.30.010	Pin Ø 2,5 mm L. 320 mm (4 pcs)	Pin graduato Ø 2,5 mm L. 320 mm (4 pz)
A6	9087.30.011	Gauge for pin	Misuratore per pin
A7	9087.30.013	Long screwdriver hex. 2,5 mm	Cacciavite lungo esagonale 2,5 mm
A8	9087.30.014	Screwdriver hex. 3,5 mm	Cacciavite esagonale 3,5 mm
A9	9087.30.015	Extractor	Estrattore
A10	9087.30.018	Protection device for initial reamer	Protezione per fresa iniziale
A11	9087.30.019	Self-locking chuck	Mandrino autoserrante
A12	9087.30.020	Guide wire exchange tube Ø 6 mm L. 400 mm	Tubo di scambio per fili guida Ø 6mm L. 400 mm
A13	9087.30.021	Reduction rod	Asta di riduzione
A14	9087.30.022	Drill for distal holes (2 pcs)	Punta per fori distali (2 pz)
A15	9087.30.024	Gauge for long nail	Misuratore per chiodo lungo
A16	9087.30.031	Short screwdriver hex. 2,5 mm	Cacciavite corto esagonale 2,5 mm
A17	9087.10.010	Measuring device	Misuratore di profondità
A18	9087.10.030	Guide wire Ø 2 mm L.155 mm	Filo guida Ø 2 mm L. 155 mm
A19	9087.30.990	Tray	Vassoio

Instrument set
Strumentario

9087.31.000		Targeting set	
B1	9087.30.106	Nail holder	Portachiodo
B2	9087.30.007	Locking bolt (2 pcs)	Bullone di serraggio (2 pz)
B3	9087.30.008	External sleeve flat tip (2 pcs)	Manicotto esterno (2 pz)
B4	9087.30.009	Internal sleeve for pin (4 pcs)	Cannula interna per pin (4 pz)
B5	9087.30.012	Wrench for locking bolt	Chiave per bullone di serraggio
B6	9087.30.017	Trocar for proximal holes	Perforatore per fori prossimali
B7	9087.30.025	Free hand drilling guide	Guida di foratura distale a mano libera
B8	9087.30.026	Countersink for distal holes	Svasatore per fori distali
B9	9087.30.027	Internal distal sleeve for drill	Cannula riduttrice punta piena
B10	9087.30.028	External sleeve for oblique tip (2 pcs)	Manicotto esterno punta obliqua (2 pz)
B11	9087.30.029	Internal distal sleeve for wire Ø 2 mm	Cannula riduttrice filo Ø 2 mm
B12	9087.30.030	Protection for locking bolt	Protezione per bullone di serraggio
B13	9087.31.990	Tray	Vassoio

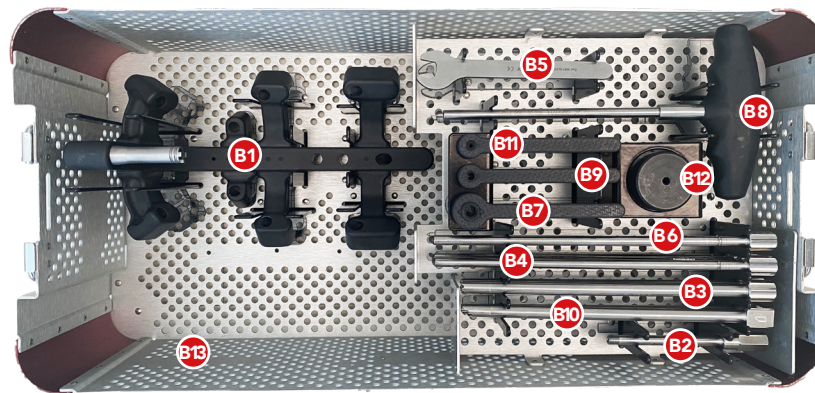

9087.32.000		Wires set Fili guida	
9087.30.003	Smooth tip (2 pcs) Punta smussa (2 pz)	Ø 2 mm L. 600 mm	
9087.30.016	Olive tip Punta ad oliva	Ø 2.5 mm L. 600 mm	

VRP - Plate

Volar radius peek plate Placca volare per radio in peek



VRP Plate Placca VRP		
CFR PEEK 30%		
L / SX	R / DX	Holes / Fori
VRP 70002L	VRP 70002R	2
VRP 70003L	VRP 70003R	3
VRP 70004L	VRP 70004L	4
VRP 70005L	VRP 70005L	5

Sterile single packaging.
Confezione singola sterile.

* Threaded head
Testa filettata

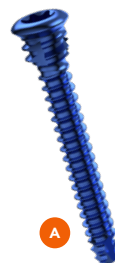

Self-threading cortical screw Vite da corticale autofilettante	
Ti6Al4V	
A Ø 2.3 mm	L [mm]
VTF 502316	16
VTF 502318	18
VTF 502320	20
VTF 502322	22
VTF 502324	24

Sterile single packaging.
Confezione singola sterile.



Self-threading cortical screw with flat head Vite da corticale autofilettante con testa piatta	
Ti6Al4V	
A Ø 3.5 mm	L [mm]
VTP 503512	12
VTP 503514	14
VTP 503516	16

Sterile single packaging.
Confezione singola sterile.

* Threaded head
Testa filettata



Self-threading cortical screw Vite da corticale autofilettante	
Ti6Al4V	
A Ø 3.5 mm	L [mm]
VTF 503512	12
VTF 503514	14
VTF 503516	16
VTF 503518	18

Sterile single packaging.
Confezione singola sterile.

A Tip diameter / Diametro di punta

L Length with screw head / Lunghezza con la testa della vite
* Threaded head / Testa filettata

Instrument set Strumentario

	VRP 700000	Complete set	Set completo
1	3617-010	Proximal measuring device	Misuratore prossimale
2	VRP 010160	Distal drill bit Ø 1.6 mm (2 pcs)	Punta distale Ø 1,6 mm (2 pz)
3	3600-025	Proximal drill bit Ø 2.5 mm	Punta prossimale Ø 2,5 mm
4	STR 030200	2 mm hexagonal screwdriver	Cacciavite esagonale da 2 mm
5	STR 100250	Proximal drilling guide	Guida di foratura prossimale
6	VRP 240130	Sleeve for guide wire	Manicotto per filo guida
7	VRP 240180	Sleeve for distal drill bit	Manicotto per punta distale
8	VRP 25000L	Distal drilling guide - left	Guida di foratura distale - sinistra
9	VRP 25000R	Distal drilling guide - right	Guida di foratura distale - destra
10	STR 030T80	Torx screwdriver T8	Cacciavite Torx T8
11	STR 051215	Guide wire Ø 1.2 mm L.155 mm (2 pcs)	Filo guida Ø 1,2 mm L.155 mm (2 pz)
12	STR 13A129	Straight handle with AO coupling	Impugnatura retta con attacco AO
13	VRP 090000	Tray	Vassoio

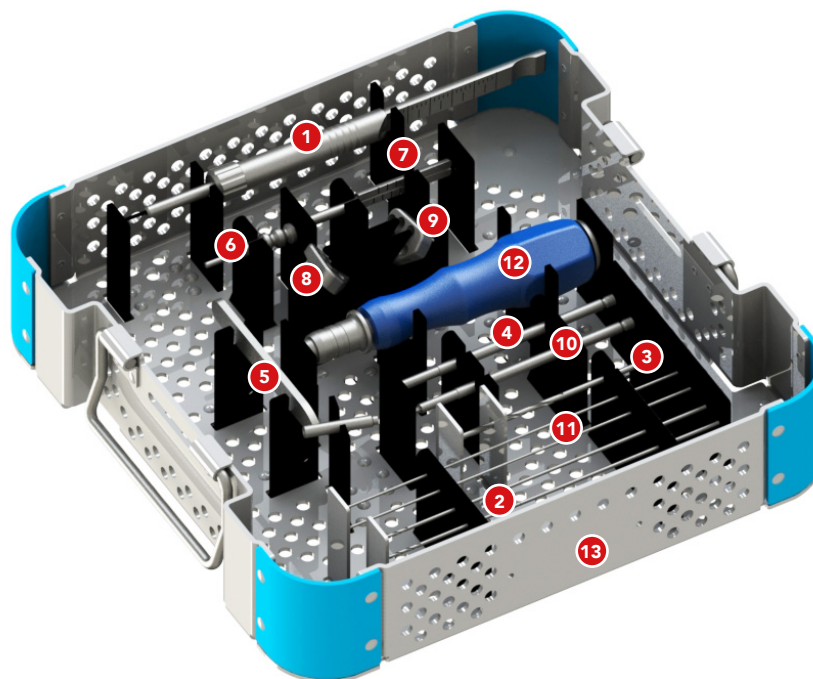

Epibloc.1

External fixator for distal radius and proximal humerus fractures Fissatore esterno per fratture di radio distale e omero prossimale

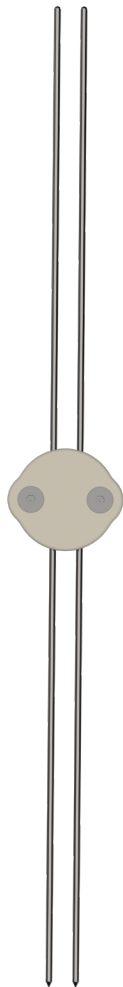

Epibloc.1
Epibloc.1

ABS M205FC / AISI 316L ESR

HME 0100	Assembly with wires Assemblaggio con fili	Ø 2 mm L. 300 mm
HME 0101	Assembly with wires Assemblaggio con fili	Ø 2.5 mm L. 500 mm

Sterile single packaging.
Confezione singola sterile.

Instrument Strumentario

STR 031250	Cannulated screwdriver * Cacciavite cannulato *	Ø 2.5 mm
STR 13R127	Cannulated straight handle * Impugnatura retta cannulata *	

* 1/4" coupling / Attacco 1/4"

Ø Hegaxon / Esagono

Coraco clavicular screw Vite coraco clavare



Screw Vite			
Ti6Al4V			
A \varnothing 6.5 mm	L [mm]	L _T [mm]	
HMV 225-030ST	30	20	
HMV 225-035ST	35	20	
HMV 225-040ST	40	20	
HMV 225-045ST	45	25	
HMV 225-050ST	50	25	

Sterile single packaging.
Confezione singola sterile.

A Tip diameter / Diametro di punta

L_T Thread length / Lunghezza filetto



Washer Rondella		
Ti6Al4V		
	B \varnothing [mm]	C \varnothing [mm]
HMV 356ST	13	6.7

Sterile single packaging.
Confezione singola sterile.

B External diameter / Diametro esterno

C Internal diameter / Diametro interno

Instrument set Strumentario

HMV 226	Graduated guide wire <i>Filo guida graduato</i>	\varnothing 1.5 mm, L. 155 mm
HMV 450-000	Drill bit <i>Punta da trapano</i>	\varnothing 3.2 mm
STR 031350	Cannulated screwdriver * <i>Cacciavite cannulato *</i>	\varnothing 3.5 mm
STR 13R127	Cannulated straight handle * <i>Impugnatura retta cannulata *</i>	
STR 06050B	Cannulated countersink * <i>Frangicorticale cannulato *</i>	\varnothing 5 x 2 mm
STR 150020	Cannulated T handle * <i>Impugnatura a T cannulata *</i>	
HMV 227	Multihole sleeve <i>Guida multiforo</i>	
HMV 106-000	Tray <i>Vassoio</i>	

* 1/4" coupling / Attacco 1/4"

Hexagon / Esagono

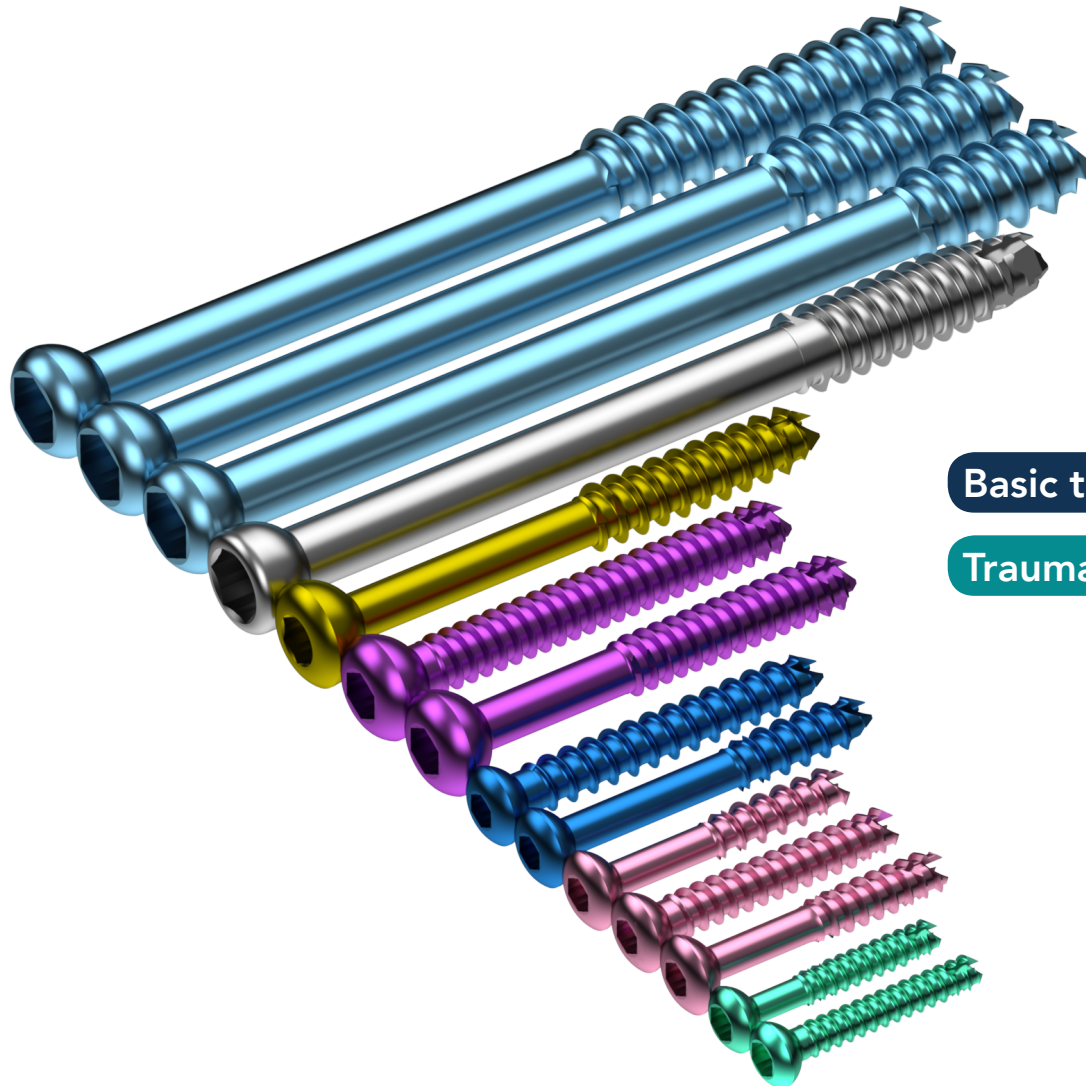

Basic trauma

Trauma di base

Self-drilling and self-tapping cannulated screws Viti cannulate autoperforanti e autofilettanti



Cortical screw full thread Vite da corticale filetto totale

Ti6Al4V

A Ø 2.7 mm
B Ø 1.1 mm

	L [mm]
HMV 110-010ST	10
HMV 110-012ST	12
HMV 110-014ST	14
HMV 110-016ST	16
HMV 110-018ST	18
HMV 110-020ST	20
HMV 110-022ST	22
HMV 110-024ST	24
HMV 110-026ST	26
HMV 110-028ST	28
HMV 110-030ST	30

Sterile single packaging.
Confezione singola sterile.



Cortical screw partial thread Vite da corticale filetto parziale

Ti6Al4V

A Ø 2.7 mm
B Ø 1.1 mm

	L [mm]	L _T
HMV 111-010ST	10	8
HMV 111-012ST	12	
HMV 111-014ST	14	12
HMV 111-016ST	16	
HMV 111-018ST	18	
HMV 111-020ST	20	
HMV 111-022ST	22	
HMV 111-024ST	24	
HMV 111-026ST	26	20
HMV 111-028ST	28	
HMV 111-030ST	30	

Sterile single packaging.
Confezione singola sterile.



Cancellous screw partial thread Vite da spongiosa filetto parziale

Ti6Al4V

A Ø 3.5 mm
B Ø 1.6 mm

	L [mm]	L _T [mm]
HMV 114-010ST	10	8
HMV 114-012ST	12	10
HMV 114-014ST	14	16
HMV 114-016ST	16	
HMV 114-018ST	18	
HMV 114-020ST	20	
HMV 114-022ST	22	
HMV 114-024ST	24	
HMV 114-026ST	26	20
HMV 114-028ST	28	
HMV 114-030ST	30	
HMV 114-032ST	32	
HMV 114-034ST	34	20
HMV 114-036ST	36	
HMV 114-038ST	38	
HMV 114-040ST	40	
HMV 114-042ST	42	
HMV 114-044ST	44	
HMV 114-046ST	46	20
HMV 114-048ST	48	
HMV 114-050ST	50	
HMV 114-055ST	55	
HMV 114-060ST	60	
HMV 114-065ST	65	
HMV 114-070ST	70	

Sterile single packaging.
Confezione singola sterile.

Hexagonal socket
Cava esagonale
Ø 2.5 mm



A Tip diameter / Diametro di punta
B Cannulation / Cannulazione

L_T Thread length / Lunghezza filetto

Cortical screw full thread
Vite da corticale filetto totale

Ti6Al4V

A Ø 3.5 mm
B Ø 1.6 mm

L [mm]

HMV 115-010ST	10
HMV 115-012ST	12
HMV 115-014ST	14
HMV 115-016ST	16
HMV 115-018ST	18
HMV 115-020ST	20
HMV 115-022ST	22
HMV 115-024ST	24
HMV 115-026ST	26
HMV 115-028ST	28
HMV 115-030ST	30
HMV 115-032ST	32
HMV 115-034ST	34
HMV 115-036ST	36
HMV 115-038ST	38
HMV 115-040ST	40
HMV 115-042ST	42
HMV 115-044ST	44
HMV 115-046ST	46
HMV 115-048ST	48
HMV 115-050ST	50
HMV 115-055ST	55
HMV 115-060ST	60
HMV 115-065ST	65
HMV 115-070ST	70

Sterile single packaging.
 Confezione singola sterile.

Cortical screw partial thread
Vite da corticale filetto parziale

Ti6Al4V

A Ø 3.5 mm
B Ø 1.6 mm

L [mm]

L_T [mm]

HMV 116-010ST	10	8.5
HMV 116-012ST	12	10.5
HMV 116-014ST	14	
HMV 116-016ST	16	
HMV 116-018ST	18	
HMV 116-020ST	20	
HMV 116-022ST	22	12
HMV 116-024ST	24	
HMV 116-026ST	26	
HMV 116-028ST	28	
HMV 116-030ST	30	
HMV 116-032ST	32	
HMV 116-034ST	34	
HMV 116-036ST	36	
HMV 116-038ST	38	
HMV 116-040ST	40	16
HMV 116-042ST	42	
HMV 116-044ST	44	
HMV 116-046ST	46	
HMV 116-048ST	48	
HMV 116-050ST	50	
HMV 116-055ST	55	
HMV 116-060ST	60	20
HMV 116-065ST	65	
HMV 116-070ST	70	

Sterile single packaging.
 Confezione singola sterile.

Hexagonal socket
 Cava esagonale

∅ 2.5 mm



A Tip diameter / Diametro di punta
B Cannulation / Cannulazione

L_T Thread length / Lunghezza filetto

Cancellous screw full thread Vite da spongiosa filetto totale

Ti6Al4V

A Ø 4 mm
B Ø 1.6 mm

L [mm]

HMV 136-010ST	10
HMV 136-012ST	12
HMV 136-014ST	14
HMV 136-016ST	16
HMV 136-018ST	18
HMV 136-020ST	20
HMV 136-022ST	22
HMV 136-024ST	24
HMV 136-026ST	26
HMV 136-028ST	28
HMV 136-030ST	30
HMV 136-032ST	32
HMV 136-034ST	34
HMV 136-036ST	36
HMV 136-038ST	38
HMV 136-040ST	40
HMV 136-042ST	42
HMV 136-044ST	44
HMV 136-046ST	46
HMV 136-048ST	48
HMV 136-050ST	50
HMV 136-055ST	55
HMV 136-060ST	60
HMV 136-065ST	65
HMV 136-070ST	70

Sterile single packaging.
Confezione singola sterile.

Hexagonal socket
Cava esagonale
Ø 2.5 mm



Cancellous screw partial thread Vite da spongiosa filetto parziale

Ti6Al4V

A Ø 4 mm
B Ø 1.6 mm

L [mm]

L_T [mm]

HMV 135-010ST	10	8
HMV 135-012ST	12	10
HMV 135-014ST	14	
HMV 135-016ST	16	
HMV 135-018ST	18	
HMV 135-020ST	20	
HMV 135-022ST	22	12
HMV 135-024ST	24	
HMV 135-026ST	26	
HMV 135-028ST	28	
HMV 135-030ST	30	
HMV 135-032ST	32	
HMV 135-034ST	34	
HMV 135-036ST	36	
HMV 135-038ST	38	
HMV 135-040ST	40	
HMV 135-042ST	42	
HMV 135-044ST	44	
HMV 135-046ST	46	16
HMV 135-048ST	48	
HMV 135-050ST	50	
HMV 135-055ST	55	
HMV 135-060ST	60	
HMV 135-065ST	65	
HMV 135-070ST	70	

Sterile single packaging.
Confezione singola sterile.

A Tip diameter / Diametro di punta
B Cannulation / Cannulazione

L_T Thread length / Lunghezza filetto

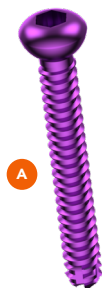
Cortical screw full thread
Vite da corticale filetto totale

Ti6Al4V

A Ø 4.5 mm**B** Ø 2.2 mm

L [mm]

HMV 120-020ST	20
HMV 120-022ST	22
HMV 120-024ST	24
HMV 120-026ST	26
HMV 120-028ST	28
HMV 120-030ST	30
HMV 120-032ST	32
HMV 120-034ST	34
HMV 120-036ST	36
HMV 120-038ST	38
HMV 120-040ST	40
HMV 120-042ST	42
HMV 120-044ST	44
HMV 120-046ST	46
HMV 120-048ST	48
HMV 120-050ST	50
HMV 120-055ST	55
HMV 120-060ST	60
HMV 120-065ST	65
HMV 120-070ST	70

Sterile single packaging.
Confezione singola sterile.

Cortical screw partial thread
Vite da corticale filetto parziale

Ti6Al4V

A Ø 4.5 mm**B** Ø 2.2 mmL_T 20 mm

L [mm]

HMV 125-026ST	26
HMV 125-028ST	28
HMV 125-030ST	30
HMV 125-032ST	32
HMV 125-034ST	34
HMV 125-036ST	36
HMV 125-038ST	38
HMV 125-040ST	40
HMV 125-042ST	42
HMV 125-044ST	44
HMV 125-046ST	46
HMV 125-048ST	48
HMV 125-050ST	50
HMV 125-055ST	55
HMV 125-060ST	60
HMV 125-065ST	65
HMV 125-070ST	70

Sterile single packaging.
Confezione singola sterile.

A Tip diameter / Diametro di punta**B** Cannulation / CannulazioneL_T Thread length / Lunghezza filetto**Hexagonal socket**

Cava esagonale

Ø 3.5 mm





Cancellous screw partial thread Vite da spongiosa filetto parziale

Ti6Al4V

A Ø 5 mm

B Ø 2.2 mm

L_T 20 mm

L [mm]

HMV 140-026ST	26
HMV 140-028ST	28
HMV 140-030ST	30
HMV 140-032ST	32
HMV 140-034ST	34
HMV 140-036ST	36
HMV 140-038ST	38
HMV 140-040ST	40
HMV 140-042ST	42
HMV 140-044ST	44
HMV 140-046ST	46
HMV 140-048ST	48
HMV 140-050ST	50
HMV 140-055ST	55
HMV 140-060ST	60
HMV 140-065ST	65
HMV 140-070ST	70

Sterile single packaging.
Confezione singola sterile.



Cancellous screw partial thread Vite da spongiosa filetto parziale

Ti6Al4V

A Ø 6.5 mm

B Ø 3.5 mm

L [mm]

L_T [mm]

HMV 200-025	25	15
HMV 200-030	30	
HMV 200-035	35	22
HMV 200-040	40	
HMV 200-045	45	
HMV 200-050	50	
HMV 200-055	55	
HMV 200-060	60	
HMV 200-065	65	
HMV 200-070	70	
HMV 200-075	75	
HMV 200-080	80	
HMV 200-085	85	
HMV 200-090	90	
HMV 200-095	95	
HMV 200-100	100	
HMV 200-105	105	
HMV 200-110	110	
HMV 200-115	115	
HMV 200-120	120	

Sterile single packaging.
Confezione singola sterile.

Hexagonal socket

Cava esagonale

Ø 3.5 mm



Hexagonal socket

Cava esagonale

Ø 5 mm



A Tip diameter / Diametro di punta

B Cannulation / Cannulazione

L_T Thread length / Lunghezza filetto

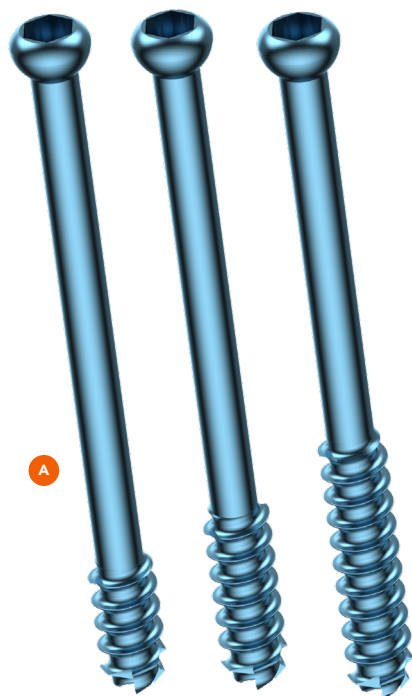

A Tip diameter / Diametro di punta
B Cannulation / Cannulazione

L_T Thread length / Lunghezza filetto

Hexagonal socket
 Cava esagonale
 \varnothing 5 mm

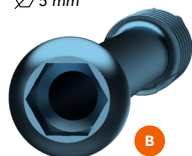

■ Upon request.
 ■ Su richiesta.

Cancellous screw partial thread Vite da spongiosa filetto parziale

Ti6Al4V

A \varnothing 7.2 mm B \varnothing 3.5 mm L_T 16 mm	A \varnothing 7.2 mm B \varnothing 3.5 mm L_T 22 mm	A \varnothing 7.2 mm B \varnothing 3.5 mm L_T 32 mm	L [mm]
HMV 202-025ST	-	-	25
HMV 202-030ST	-	-	30
HMV 202-035ST	HMV 205-035ST	-	35
HMV 202-040ST	HMV 205-040ST	HMV 204-040ST	40
HMV 202-045ST	HMV 205-045ST	HMV 204-045ST	45
HMV 202-050ST	HMV 205-050ST	HMV 204-050ST	50
HMV 202-055ST	HMV 205-055ST	HMV 204-055ST	55
HMV 202-060ST	HMV 205-060ST	HMV 204-060ST	60
HMV 202-065ST	HMV 205-065ST	HMV 204-065ST	65
HMV 202-070ST	HMV 205-070ST	HMV 204-070ST	70
HMV 202-075ST	HMV 205-075ST	HMV 204-075ST	75
HMV 202-080ST	HMV 205-080ST	HMV 204-080ST	80
HMV 202-085ST	HMV 205-085ST	HMV 204-085ST	85
HMV 202-090ST	HMV 205-090ST	HMV 204-090ST	90
HMV 202-095ST	HMV 205-095ST	HMV 204-095ST	95
HMV 202-100ST	HMV 205-100ST	HMV 204-100ST	100
HMV 202-105ST	HMV 205-105ST	HMV 204-105ST	105
HMV 202-110ST	HMV 205-110ST	HMV 204-110ST	110
HMV 202-115ST	HMV 205-115ST	HMV 204-115ST	115
HMV 202-120ST	HMV 205-120ST	HMV 204-120ST	120
■ HMV 202-125ST	■ HMV 205-125ST	■ HMV 204-125ST	125
■ HMV 202-130ST	■ HMV 205-130ST	■ HMV 204-130ST	130
■ HMV 202-135ST	■ HMV 205-135ST	■ HMV 204-135ST	135
■ HMV 202-140ST	■ HMV 205-140ST	■ HMV 204-140ST	140

Sterile single packaging.
 Confezione singola sterile.

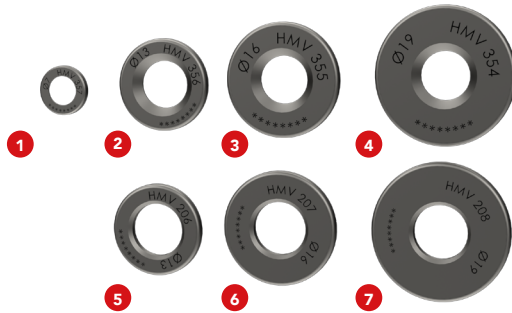

A External diameter
Diametro esterno
B Internal diameter
Diametro interno

Washer Rondella

Ti6Al4V

		Screw Ø Ø Vite	A Ø [mm]	B Ø [mm]
1	HMV 357ST	2.7 - 3.5 - 4	7	4.2
2	HMV 356ST	4.5 - 5 - 6.5	13	6.7
3	HMV 355ST	4.5 - 5 - 6.5	16	6.7
4	HMV 354ST	4.5 - 5 - 6.5	19	6.7
5	HMV 206ST	7.2	13	7.5
6	HMV 207ST	7.2	16	7.5
7	HMV 208ST	7.2	19	7.5

Sterile single packaging.
Confezione singola sterile.

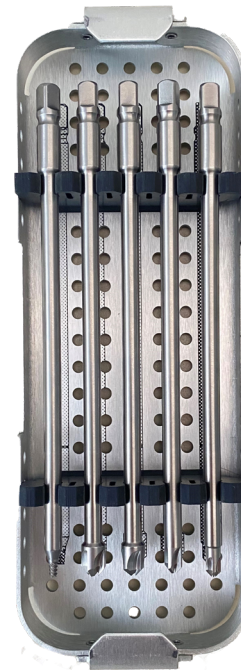
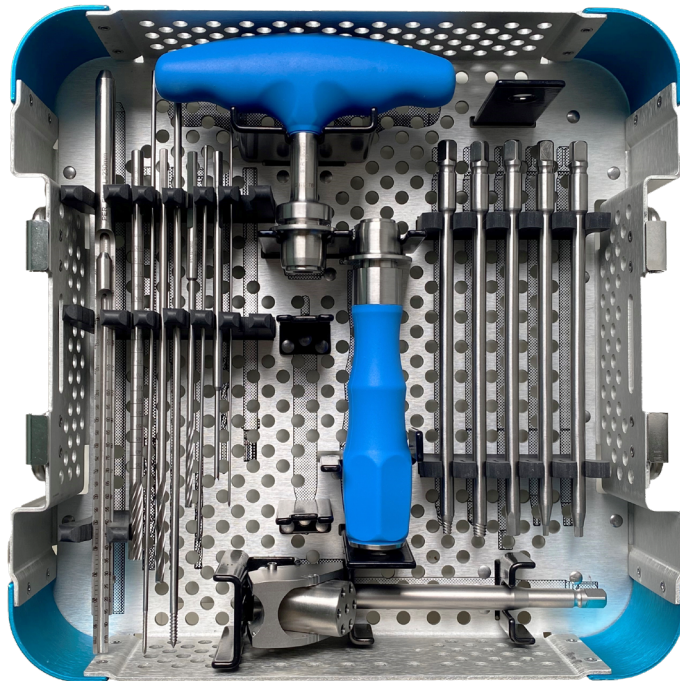

Instrument set
Strumentario**SUPERSCREWS Ø 2.7 mm HMV 110-111**

HME 353-02	Guide wire - set 10 pcs / <i>Filo guida - set 10 pz</i>	Ø 1 mm L. 155 mm
HMV 311	Cannulated drill bit / <i>Punta cannulata</i>	Ø 2 mm
HME 353-01	Guide wire measuring device / <i>Misuratore per filo guida</i>	
STR 031250	Cannulated screwdriver / <i>Cacciavite cannulato *</i>	Ø 2.5 mm
STR 13R127	Cannulated straight handle / <i>Impugnatura retta cannulata *</i>	
STR 06050A	Cannulated countersink / <i>Frangicorticale cannulato *</i>	Ø 5 x 1 mm
STR 150020	Cannulated T handle / <i>Impugnatura a T cannulata *</i>	

SUPERSCREWS Ø 3.5 mm HMV 114-115-116 / Ø 4 mm HMV 136-135

HMV 115-1	Guide wire / <i>Filo guida</i>	Ø 1.5 mm, L. 155 mm
HMV 166-28	Cannulated drill bit / <i>Punta cannulata</i>	Ø 2.8 mm
HME 353-01	Guide wire measuring device / <i>Misuratore per filo guida</i>	
STR 031250	Cannulated screwdriver / <i>Cacciavite cannulato *</i>	Ø 2.5 mm
STR 13R127	Cannulated straight handle / <i>Impugnatura retta cannulata *</i>	
STR 06060A	Cannulated countersink / <i>Frangicorticale cannulato *</i>	Ø 6 x 1.5 mm
STR 150020	Cannulated T handle / <i>Impugnatura a T cannulata *</i>	

SUPERSCREWS Ø 4.5 mm HMV 120-125 / Ø 5 mm HMV 140

HMV 353-04	Threaded guide wire / <i>Filo guida filettato</i>	Ø 2 mm; L. 230 mm
HMV 167-35	Cannulated drill bit / <i>Punta cannulata</i>	Ø 3.5 mm
HM 00110	Measuring device / <i>Misuratore</i>	
STR 031350	Cannulated screwdriver / <i>Cacciavite cannulato *</i>	Ø 3.5 mm
STR 13R127	Cannulated straight handle / <i>Impugnatura retta cannulata *</i>	
STR 06080A	Cannulated countersink / <i>Frangicorticale cannulato *</i>	Ø 8 x 2 mm
STR 150020	Cannulated T handle / <i>Impugnatura a T cannulata *</i>	

SUPERSCREWS Ø 6.5 mm HMV 200 / Ø 7.2 mm HMV 202-204-205

HMV 200-002	Guide wire / <i>Filo guida</i>	Ø 3.2 mm; L. 230 mm
HMV 200-007	Cannulated and calibrated drill bit / <i>Punta cannulata e calibrata</i>	Ø 5 mm
HM 00110	Measuring device / <i>Misuratore</i>	
HMV 200-001	Adjustable guide / <i>Guida regolabile</i>	
STR 031500	Cannulated screwdriver / <i>Cacciavite cannulato *</i>	Ø 5 mm
STR 13R127	Cannulated straight handle / <i>Impugnatura retta cannulata *</i>	
STR 06080B	Cannulated countersink / <i>Frangicorticale cannulato *</i>	Ø 8 x 3.2 mm
STR 150020	Cannulated T handle / <i>Impugnatura a T cannulata *</i>	

EXTRACTORS / ESTRATTORI

STR 081250	Extractor hex socket / <i>Estrattore cava esagonale *</i>	Ø 2.5 mm; for screw / <i>per viti</i> Ø 2.7 / 3.5 / 4 mm
STR 081350	Extractor hex socket / <i>Estrattore cava esagonale *</i>	Ø 3.5 mm; for screw / <i>per viti</i> Ø 4.5 / 5 mm
STR 081500	Extractor hex socket / <i>Estrattore cava esagonale *</i>	Ø 5 mm; for screw / <i>per viti</i> Ø 6.5 / 7.2 mm
STR 150020	Cannulated T handle / <i>Impugnatura a T cannulata *</i>	

TRAY / VASSOIO

HMV 106-000	Instrument tray / <i>Vassoio strumenti</i>	
HMV 106-001	Internal tray / <i>Vassoio interno</i>	

* 1/4" coupling / *Attacco 1/4"*Hexagon / *Esagono*

Ligament fixation staple

Cambra per legamenti



Ligament fixation staple Cambra per legamenti

CrCoMo

B 25 mm

A [mm]

With spikes Con dentini	Without spikes Senza dentini	
HMA 203-090ST	HMA 203-091ST	6
HMA 203-092ST	HMA 203-093ST	8
HMA 203-094ST	HMA 203-095ST	11
HMA 203-096ST	HMA 203-097ST	16

Sterile single packaging.
Confezione singola sterile.



Ligament fixation staple Cambra per legamenti

Ti6Al4V

B 25 mm

A [mm]

With spikes Con dentini	Without spikes Senza dentini	
HMA 260-090ST	HMA 260-091ST	6
HMA 260-092ST	HMA 260-093ST	8
HMA 260-094ST	HMA 260-095ST	11
HMA 260-096ST	HMA 260-097ST	14

Sterile single packaging.
Confezione singola sterile.

Instrument set Strumentario

HMA 206	Impactor Staple holder Impattatore Porta cambra
HMA 214	Impactor - Extractor hammer Martello impattatore - estrattore

A Leg width / Larghezza rebbi
B Leg height/ Altezza rebbi

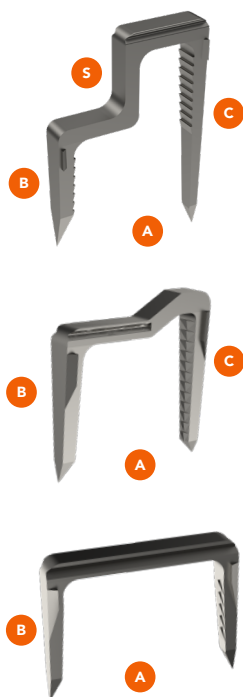

Osteotomy offset staple Cambre per osteotomia a scalino

CrCoMo

Asymmetric / Asimmetrica

A 30 mm **S [mm]** **C [mm]**
B 25 mm

HMA 205-173ST	5	35
HMA 205-174ST	10	40
HMA 205-175ST	15	45

Semi-oblique / Semi-obliqua

B 30 mm **A [mm]**
C 25 mm

HMA 205-126ST	30
HMA 205-136ST	40

Straight / Dritta

B 25 mm **A [mm]**

HMA 205-026ST	26
HMA 205-036ST	36

Sterile single packaging.
Confezione singola sterile.

Instrument set Strumentario

HMA 206	Impactor - Staple holder Impattatore - Porta cambra
HMA 214	Impactor - Extractor hammer Martello impattatore - estrattore

- A** Leg width / Larghezza rebbi
- B** Leg height/ Altezza rebbi
- C** Leg height in case of asymmetry / Altezza rebbi in caso di asimmetria
- S** Offset height/ Altezza scalino

Osteotomy staples

Cambre per osteotomia



Osteotomy Blount type staple Cambre per osteotomia tipo Blount

CrCoMo

A [mm] **B [mm]**

HMA 235-30ST	10	22
HMA 235-31ST	16	22
HMA 235-32ST	22	22
HMA 235-33ST	28	22
HMA 235-34ST	18	24

Ti6Al4V

A [mm] **B [mm]**

HMA 263-20ST	18	22
HMA 263-25ST	23	22
HMA 263-30ST	28	22

Sterile single packaging.
Confezione singola sterile.

A Leg width / Larghezza rebbi
B Leg height/ Altezza rebbi

Instrument set Strumentario

HMA 237-1	Impactor Staple holder Impattatore Porta cambra
HMA 236	Final impactor Impattatore finale
HMA 238	Extractor Estrattore

Self-threading solid screws in titanium

Viti piene autofilettanti in titanio



Cortical screw full thread
Vite da corticale filetto totale

Ti6Al4V

A Ø 2.7 mm L [mm]

HMV 191-006ST	6
HMV 191-008ST	8
HMV 191-010ST	10
HMV 191-012ST	12
HMV 191-014ST	14
HMV 191-016ST	16
HMV 191-018ST	18
HMV 191-020ST	20
HMV 191-022ST	22
HMV 191-024ST	24
HMV 191-026ST	26
HMV 191-028ST	28
HMV 191-030ST	30
HMV 191-032ST	32
HMV 191-034ST	34
HMV 191-036ST	36
HMV 191-038ST	38
HMV 191-040ST	40

Sterile single packaging.
Confezione singola sterile.



Cancellous screw total thread
Vite da spongiosa filetto totale

Ti6Al4V

A Ø 3.5 mm L [mm]

HMV 195-010ST	10
HMV 195-012ST	12
HMV 195-014ST	14
HMV 195-016ST	16
HMV 195-018ST	18
HMV 195-020ST	20
HMV 195-022ST	22
HMV 195-024ST	24
HMV 195-026ST	26
HMV 195-028ST	28
HMV 195-030ST	30
HMV 195-032ST	32
HMV 195-034ST	34
HMV 195-036ST	36
HMV 195-038ST	38
HMV 195-040ST	40
HMV 195-045ST	45
HMV 195-050ST	50
HMV 195-055ST	55
HMV 195-060ST	60

Sterile single packaging.
Confezione singola sterile.

A Tip diameter / Diametro di punta

Titanium osteosynthesis



A Tip diameter / Diametro di punta

L_T Thread length / Lunghezza filetto

Cortical screw partial thread Vite da corticale filetto parziale

Ti6Al4V

A Ø 3.5 mm	L [mm]	L _T [mm]
HMV 101-010ST	10	
HMV 101-012ST	12	
HMV 101-014ST	14	
HMV 101-016ST	16	8
HMV 101-018ST	18	
HMV 101-020ST	20	
HMV 101-022ST	22	
HMV 101-024ST	24	
HMV 101-026ST	26	10
HMV 101-028ST	28	
HMV 101-030ST	30	
HMV 101-032ST	32	
HMV 101-034ST	34	
HMV 101-036ST	36	
HMV 101-038ST	38	
HMV 101-040ST	40	16
HMV 101-042ST	42	
HMV 101-044ST	44	
HMV 101-046ST	46	
HMV 101-048ST	48	
HMV 101-050ST	50	
HMV 101-055ST	55	
HMV 101-060ST	60	
HMV 101-065ST	65	
HMV 101-070ST	70	
■ HMV 101-075ST	75	
■ HMV 101-080ST	80	
■ HMV 101-085ST	85	20
■ HMV 101-090ST	90	
■ HMV 101-095ST	95	
■ HMV 101-100ST	100	
■ HMV 101-105ST	105	
■ HMV 101-110ST	110	
■ HMV 101-115ST	115	
■ HMV 101-120ST	120	

Sterile single packaging.
Confezione singola sterile.



Cortical screw total thread Vite da corticale filetto totale

Ti6Al4V

A Ø 3.5 mm	L [mm]
HMV 100-010ST	10
HMV 100-012ST	12
HMV 100-014ST	14
HMV 100-016ST	16
HMV 100-018ST	18
HMV 100-020ST	20
HMV 100-022ST	22
HMV 100-024ST	24
HMV 100-026ST	26
HMV 100-028ST	28
HMV 100-030ST	30
HMV 100-032ST	32
HMV 100-034ST	34
HMV 100-036ST	36
HMV 100-038ST	38
HMV 100-040ST	40
HMV 100-042ST	42
HMV 100-044ST	44
HMV 100-046ST	46
HMV 100-048ST	48
HMV 100-050ST	50
HMV 100-055ST	55
HMV 100-060ST	60
HMV 100-065ST	65
HMV 100-070ST	70
■ HMV 100-075ST	75
■ HMV 100-080ST	80
■ HMV 100-085ST	85
■ HMV 100-090ST	90
■ HMV 100-095ST	95
■ HMV 100-100ST	100
■ HMV 100-105ST	105
■ HMV 100-110ST	110
■ HMV 100-115ST	115
■ HMV 100-120ST	120

Sterile single packaging.
Confezione singola sterile.

- Upon request.
- Su richiesta.



Cancellous screw partial thread Vite da spongiosa filetto parziale

Ti6Al4V

A Ø 4 mm	L [mm]	L _T [mm]
HMV 131-010ST	10	
HMV 131-012ST	12	8
HMV 131-014ST	14	
HMV 131-016ST	16	10
HMV 131-018ST	18	
HMV 131-020ST	20	
HMV 131-022ST	22	12
HMV 131-024ST	24	
HMV 131-026ST	26	
HMV 131-028ST	28	
HMV 131-030ST	30	14
HMV 131-035ST	35	
HMV 131-040ST	40	
HMV 131-045ST	45	
HMV 131-050ST	50	
HMV 131-055ST	55	16
HMV 131-060ST	60	
HMV 131-065ST	65	
HMV 131-070ST	70	

Sterile single packaging.
Confezione singola sterile.

A Tip diameter / Diametro di punta

L_T Thread length / Lunghezza filetto



Cancellous screw total thread Vite da spongiosa filetto totale

Ti6Al4V

A Ø 4 mm	L [mm]
HMV 130-010ST	10
HMV 130-012ST	12
HMV 130-014ST	14
HMV 130-016ST	16
HMV 130-018ST	18
HMV 130-020ST	20
HMV 130-022ST	22
HMV 130-024ST	24
HMV 130-026ST	26
HMV 130-028ST	28
HMV 130-030ST	30
HMV 130-032ST	32
HMV 130-034ST	34
HMV 130-036ST	36
HMV 130-038ST	38
HMV 130-040ST	40
HMV 130-042ST	42
HMV 130-044ST	44
HMV 130-046ST	46
HMV 130-048ST	48
HMV 130-050ST	50
HMV 130-055ST	55
HMV 130-060ST	60
HMV 130-065ST	65
HMV 130-070ST	70
■ HMV 130-075ST	75
■ HMV 130-080ST	80
■ HMV 130-085ST	85
■ HMV 130-090ST	90
■ HMV 130-095ST	95
■ HMV 130-100ST	100
■ HMV 130-105ST	105
■ HMV 130-110ST	110
■ HMV 130-115ST	115
■ HMV 130-120ST	120

Sterile single packaging.
Confezione singola sterile.

- Upon request.
- Su richiesta.

Titanium osteosynthesis



Cortical screw full thread Vite da corticale filetto totale

Ti6Al4V

A Ø 4.5 mm	L [mm]
HMV 105-014ST	14
HMV 105-016ST	16
HMV 105-018ST	18
HMV 105-020ST	20
HMV 105-022ST	22
HMV 105-024ST	24
HMV 105-026ST	26
HMV 105-028ST	28
HMV 105-030ST	30
HMV 105-032ST	32
HMV 105-034ST	34
HMV 105-036ST	36
HMV 105-038ST	38
HMV 105-040ST	40
HMV 105-042ST	42
HMV 105-044ST	44
HMV 105-046ST	46
HMV 105-048ST	48
HMV 105-050ST	50
HMV 105-052ST	52
HMV 105-054ST	54
HMV 105-056ST	56
HMV 105-058ST	58
HMV 105-060ST	60
HMV 105-062ST	62
HMV 105-064ST	64
HMV 105-066ST	66
HMV 105-068ST	68
HMV 105-070ST	70

Sterile single packaging.
Confezione singola sterile.



Washer Rondella

Ti6Al4V

A External diameter
Diametro esterno
B Internal diameter
Diametro interno

	Screw Ø Ø Vite	A Ø [mm]	B Ø [mm]
HMV 357ST	2.7-3.5-4	7	4.2
HMV 356ST	4.5	13	6.7
HMV 355ST	4.5	16	6.7
HMV 354ST	4.5	19	6.7

Sterile single packaging.
Confezione singola sterile.

Instrument set HMV 100-101 Strumentario HMV 100-101

HMV 100-101

3600-025	Cannulated drill bit Punta cannulata	Ø 2.5 mm
3609-010	Screwdriver Cacciavite	Ø 2.5 mm
3617-010	Measuring device Misuratore	

HMV 191-195-130-131

3600-020	Cannulated drill bit Punta cannulata	Ø 2 mm
3609-010	Screwdriver Cacciavite	Ø 2.5 mm
3617-010	Measuring device Misuratore	

HMV 105

3600-032	Cannulated drill bit Punta cannulata	Ø 3.2 mm
3610-000	Screwdriver Cacciavite	Ø 3.5 mm
3617-015	Measuring device Misuratore	

⊘ Hegaxon / Esagono

A Tip diameter / Diametro di punta



Aesculap coupling and aesculap cutting edge
Attacco aesculap e taglienti aesculap

AISI 420

	Drill bit / Punta Ø [mm]	Guide wire / Filo guida Ø [mm]
HMK 795-060	6	2
HMK 795-065	6.5	2
HMK 795-070	7	2
HMK 795-075	7.5	2
HMK 795-080	8	3
HMK 795-085	8.5	3
HMK 795-090	9	3
HMK 795-095	9.5	3
HMK 795-100	10	3
HMK 795-105	10.5	3
HMK 795-110	11	3
HMK 795-115	11.5	3
HMK 795-120	12	3
HMK 795-125	12.5	3
HMK 795-130	13	3
HMK 795-135	13.5	3
HMK 795-140	14	3
HMK 795-145	14.5	3
HMK 795-150	15	3
HMK 795-155	15.5	3
HMK 795-160	16	3
HMK 795-165	16.5	3
HMK 795-170	17	3
HMK 795-175	17.5	3
HMK 795-180	18	3

Non sterile single packaging.
Confezione singola non sterile.



AO-synthes coupling and aesculap cutting edge
Attacco AO-synthes e taglienti aesculap

AISI 420

	Drill bit / Punta Ø [mm]	Guide wire / Filo guida Ø [mm]
HMK 796-060	6	2
HMK 796-065	6.5	2
HMK 796-070	7	2
HMK 796-075	7.5	2
HMK 796-080	8	3
HMK 796-085	8.5	3
HMK 796-090	9	3
HMK 796-095	9.5	3
HMK 796-100	10	3
HMK 796-105	10.5	3
HMK 796-110	11	3
HMK 796-115	11.5	3
HMK 796-120	12	3
HMK 796-125	12.5	3
HMK 796-130	13	3
HMK 796-135	13.5	3
HMK 796-140	14	3
HMK 796-145	14.5	3
HMK 796-150	15	3
HMK 796-155	15.5	3
HMK 796-160	16	3
HMK 796-165	16.5	3
HMK 796-170	17	3
HMK 796-175	17.5	3
HMK 796-180	18	3

Non sterile single packaging.
Confezione singola non sterile.

Flexible reamers Alesatori flessibili

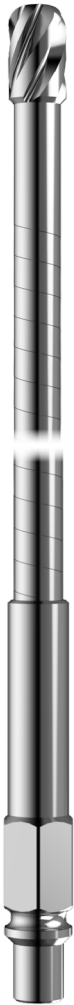

AO-synthes coupling and osteo cutting edge Attacco AO-synthes e tagliente osteo

AISI 420

	Drill bit / Punta Ø [mm]	Guide wire / Filo guida Ø [mm]
HMK 797-060	6	2
HMK 797-065	6.5	2
HMK 797-070	7	2
HMK 797-075	7.5	2
HMK 797-080	8	3
HMK 797-085	8.5	3
HMK 797-090	9	3
HMK 797-095	9.5	3
HMK 797-100	10	3
HMK 797-105	10.5	3
HMK 797-110	11	3
HMK 797-115	11.5	3
HMK 797-120	12	3
HMK 797-125	12.5	3
HMK 797-130	13	3
HMK 797-135	13.5	3
HMK 797-140	14	3
HMK 797-145	14.5	3
HMK 797-150	15	3
HMK 797-155	15.5	3
HMK 797-160	16	3
HMK 797-165	16.5	3
HMK 797-170	17	3
HMK 797-175	17.5	3
HMK 797-180	18	3



Instrument set Strumentario

HMK 792-3	Guide wire for reamers from Ø 6 to 7.5 mm Filo guida per alesatori da Ø 6 a 7,5 mm	Ø 2 mm; L. 800 olive tip / punta ad oliva Ø 2.8 mm
HSN 0235	Guide wire for reamers from Ø 8 to 18 mm Filo guida per alesatori da Ø 8 a 18 mm	Ø 3 mm; L. 800 olive tip / punta ad oliva Ø 4 mm

Non sterile single packaging.
Confezione singola non sterile.



Single trocar point
Punta singola trocar

AISI 316L ESR

L 155 mm	L 310 mm	Ø [mm]
HME 740-08	HME 741-08	0.8
HME 740-10	HME 741-10	1
HME 740-12	HME 741-12	1.2
HME 740-14	HME 741-14	1.4
HME 740-15	HME 741-15	1.5
HME 740-16	HME 741-16	1.6
HME 740-18	HME 741-18	1.8
HME 740-20	HME 741-20	2
■ HME 740-22	■ HME 741-22	2.2
HME 740-25	HME 741-25	2.5
HME 740-30	HME 741-30	3
HME 740-35	HME 741-35	3.5
HME 740-40	HME 741-40	4

Non sterile packaging, set of 10 pcs.

Confezione non sterile da 10 pz.



Double trocar point
Punta doppia trocar

AISI 316L ESR

L 155 mm	L 200 mm	L 310 mm	Ø [mm]
HME 742-08	HME 747/1-08	HME 743-08	0.8
HME 742-10	HME 747/1-10	HME 743-10	1
HME 742-12	HME 747/1-12	HME 743-12	1.2
HME 742-14	HME 747/1-14	HME 743-14	1.4
HME 742-15	HME 747/1-15	HME 743-15	1.5
HME 742-16	HME 747/1-16	HME 743-16	1.6
HME 742-18	HME 747/1-18	HME 743-18	1.8
HME 742-20	HME 747/1-20	HME 743-20	2
■ HME 742-22	■ HME 747/1-22	■ HME 743-22	2.2
HME 742-25	HME 747/1-25	HME 743-25	2.5
HME 742-30	HME 747/1-30	HME 743-30	3
HME 742-35	HME 747/1-35	HME 743-35	3.5
HME 742-40	HME 747/1-40	HME 743-40	4

Non sterile packaging, set of 10 pcs.

Confezione non sterile da 10 pz.

- Upon request.
- Su richiesta.



Single bayonet point
Punta lancia singola

AISI 316L ESR

L 155 mm	L 310 mm	Ø [mm]
HME 744-08	HME 745-08	0.8
HME 744-10	HME 745-10	1
HME 744-12	HME 745-12	1.2
HME 744-14	HME 745-14	1.4
HME 744-15	HME 745-15	1.5
HME 744-16	HME 745-16	1.6
HME 744-18	HME 745-18	1.8
HME 744-20	HME 745-20	2
■ HME 744-22	■ HME 745-22	2.2
HME 744-25	HME 745-25	2.5
HME 744-30	HME 745-30	3
HME 744-35	HME 745-35	3.5
HME 744-40	HME 745-40	4

Non sterile packaging, set of 10 pcs.
Confezione non sterile da 10 pz.



Double bayonet point
Punta lancia doppia

AISI 316L ESR

L 155 mm	L 200 mm	L 310 mm	Ø [mm]
HME 746-08	HME 747-08	HME 748-08	0.8
HME 746-10	HME 747-10	HME 748-10	1
HME 746-12	HME 747-12	HME 748-12	1.2
HME 746-14	HME 747-14	HME 748-14	1.4
HME 746-15	HME 747-15	HME 748-15	1.5
HME 746-16	HME 747-16	HME 748-16	1.6
HME 746-18	HME 747-18	HME 748-18	1.8
HME 746-20	HME 747-20	HME 748-20	2
■ HME 746-22	■ HME 747-22	■ HME 748-22	2.2
HME 746-25	HME 747-25	HME 748-25	2.5
HME 746-30	HME 747-30	HME 748-30	3
HME 746-35	HME 747-35	HME 748-35	3.5
HME 746-40	HME 747-40	HME 748-40	4

Non sterile packaging, set of 10 pcs.
Confezione non sterile da 10 pz.

■ Upon request.
■ Su richiesta.



Single trocar point
Punta singola trocar

Ti6Al4V

L 140 mm	L 280 mm	Ø [mm]
HME 770-10	HME 780-10	1
HME 770-12	HME 780-12	1.2
HME 770-15	HME 780-15	1.5
HME 770-20	HME 780-20	2
HME 770-25	HME 780-25	2.5
HME 770-30	HME 780-30	3

Non sterile single packaging.
Confezione singola non sterile.



Suture passing wires with holes Fili forati passanti per suture

AISI 316L ESR

L 300 mm	Ø [mm]
HME 749-20	2
HME 749-25	2.5
HME 749-30	3

Non sterile single packagin.
Confezione singola non sterile.



Ghisellini's wires for clavicle fracture Fili tipo Ghisellini per fratture di clavicola

AISI 316L ESR

L 280 mm	Ø [mm]
HME 860-20	2
HME 860-25	2.5
HME 860-30	3
HME 860-35	3.5
HME 860-40	4
HME 860-45	4.5
HME 860-50	5

Non sterile packaging, set of 10 pcs.
Confezione non sterile da 10 pz.



Steinmann pins Chiodi di Steinmann

AISI 316L ESR

L 150 mm	Ø [mm]
HME 235-150	3.5
HME 240-150	4
HME 245-150	4.5
HME 250-150	5

L 200 mm	Ø [mm]
HME 235-200	3.5
HME 240-200	4
HME 245-200	4.5
HME 250-200	5

L 250 mm	Ø [mm]
HME 235-250	3.5
HME 240-250	4
HME 245-250	4.5
HME 250-250	5

Non sterile single packagin.
Confezione singola non sterile.



Cerclage with spacers
Cerchiaggio con spaziatori

	Cable / Cavo: Ti6Al4V Spacers / Spaziatori: CP titanium	
HME 858	Cerclage with cable crimper <i>Cerchiaggio con terminale</i>	Ø 1.8 mm L. 900 mm
HME 859	Set of 6 spacers <i>Set 6 spaziatori</i>	

Sterile single packaging.
Confezione singola sterile.

Instrument set
Strumentario

1	HME 866	Cable tensioner	<i>Tensionatore per cavo</i>
2	HME 867	Cable crimper	<i>Pinza di serraggio</i>
3	HME 869-1	Cable passer small	<i>Passacavo piccolo</i>
4	HME 869-2	Cable passer large	<i>Passacavo grande</i>
5	HMG 0917	Cable cutter (for wire up to Ø 2.5 mm)	<i>Tronchese (per fili fino a Ø 2,5 mm)</i>
6	DCD 090000	Tray	<i>Vassoio</i>

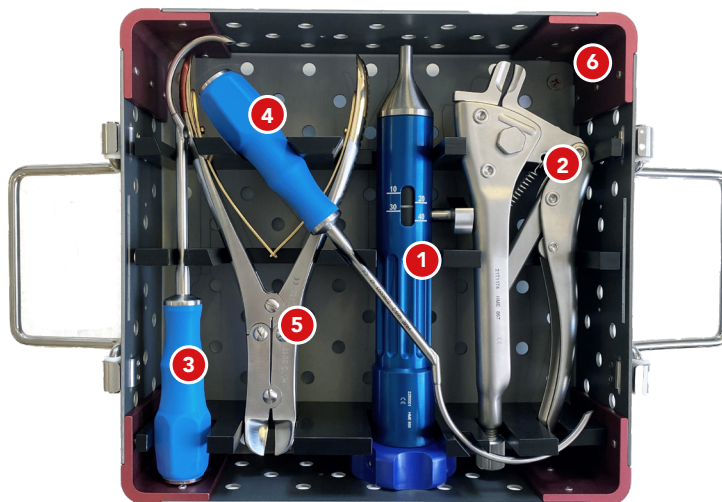

Traditional cerclages Cerchiaggi tradizionali



Malleable cerclage wire Filo per cerchiaggio malleabile

AISI 316L ESR

Coil / Rotolo L 10 mt	Ø [mm]
HME 835	0.8
HME 837	1
HME 838	1.2
HME 839	1.5

Non sterile single packaging.
Confezione singola non sterile.



Cerclage wire with eye Filo di cerchiaggio con asola

AISI 316L ESR

	Ø [mm]	L [mm]
HME 850-08	0.8	280
HME 850-10	1	280
HME 850-12	1,2	280
HME 851-10	1	600
HME 851-12	1.2	600

Non sterile single packaging.
Confezione singola non sterile.

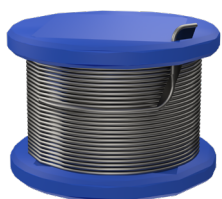

Malleable cerclage wire Filo per cerchiaggio malleabile

CP titanium

Coil / Rotolo L 5 mt	Ø [mm]
HME 781	1

Non sterile single packaging.
Confezione singola non sterile.

Cerclage wire with eye Filo di cerchiaggio con asola

CP titanium

	Ø [mm]	L [mm]
HME 857-12	1.2	300

Non sterile single packaging.
Confezione singola non sterile.

Instrument set Strumentario

HME 852	Wire tightener	Tendifilo
---------	----------------	-----------



Bone band
Fascetta per cerchiaggio

CP titanium

HME 853

Thickness 0.5 mm L. 270 mm
Spessore 0,5 mm L. 270 mm

Sterile single packaging.
Confezione singola sterile.

Instrument set
Strumentario

HME 854-2	Positioner	<i>Posizionatore</i>
HME 855	Tightener	<i>Tenditore</i>
HME 856	Bender	<i>Piegatore</i>

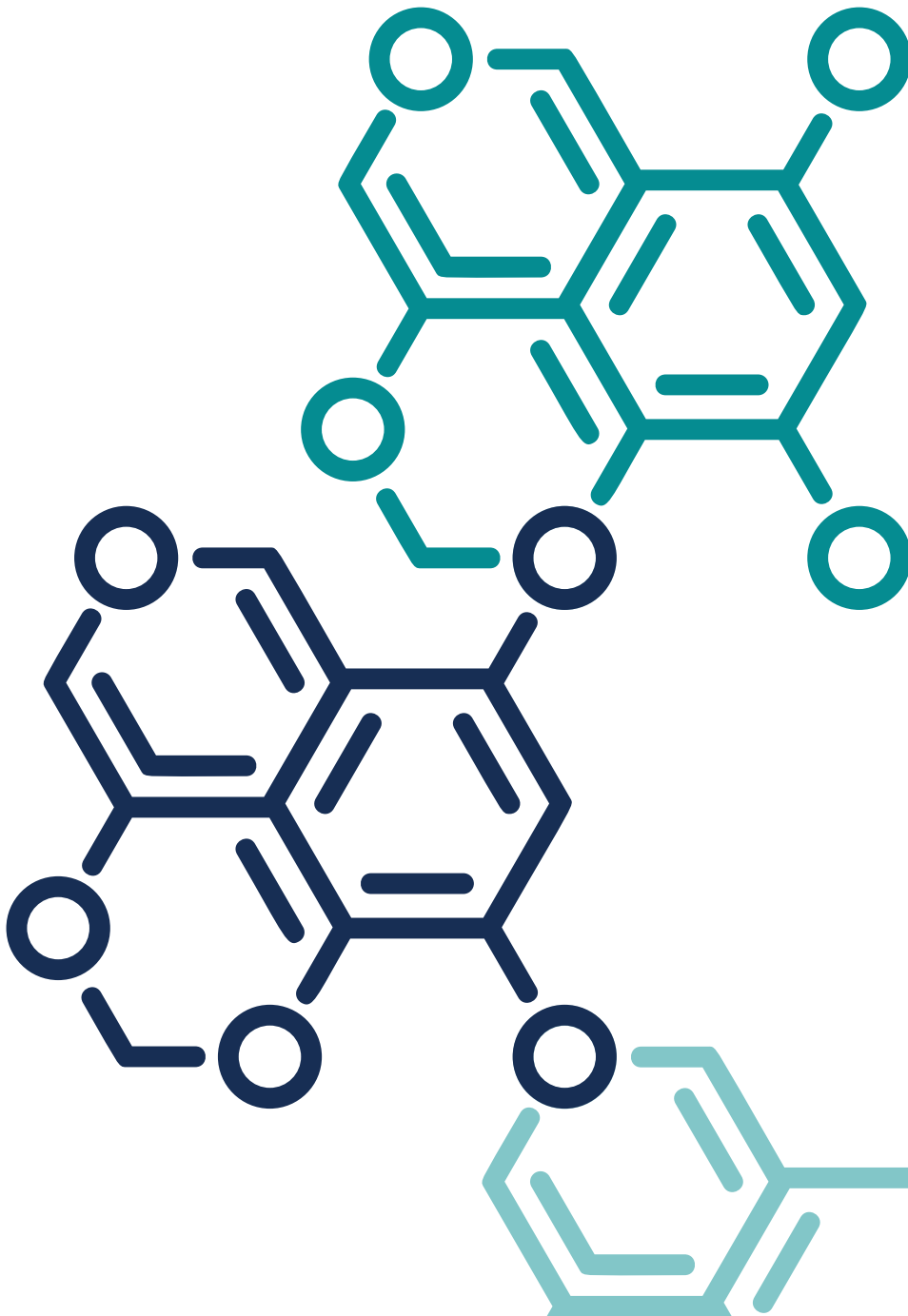

Rigenerative
medicine

Medicina
rigenerativa

Lipo-Med LIP-001

Natural adipose tissue Tessuto adiposo naturale

Lipo-Med

Lipo-Med is a sterile single-use medical device intended for the closed-loop processing and transferring of autologous adipose tissue for intra-articular treatment of osteoarthritis of 2-3° or, where prosthetic surgery is not possible, as a repeatable procedure to treat painful symptoms.

Lipo-Med is equipped with a semipermeable membrane that separates adipose tissue from waste elements with the help of continuous irrigation.

The dialysis of the tissue minimizes the stress and trauma to cell and extracellular matrix architecture, removing the blood and oil residues that are proinflammatory.

The final product is a purified adipose tissue reduced into clusters.

Lipo-Med

Il sistema Lipo-Med è un dispositivo medico sterile monouso a circuito chiuso destinato al trattamento e al trasferimento di tessuto adiposo autologo per il trattamento intrarticolare dell'artrosi di 2-3° o, laddove non sia possibile l'intervento chirurgico protesico, come trattamento ripetibile per gestire la sintomatologia dolorosa.

Il sistema Lipo-Med è dotato di una membrana semipermeabile in grado di separare il tessuto adiposo dagli elementi di scarto grazie a un lavaggio continuo. La dialisi del tessuto minimizza gli stress a carico delle cellule mantenendo integra l'architettura della matrice extracellulare, rimuovendo i residui ematici ed oleosi a carattere proinfiammatorio.

Il prodotto finale è un tessuto adiposo purificato e ridotto in cluster.

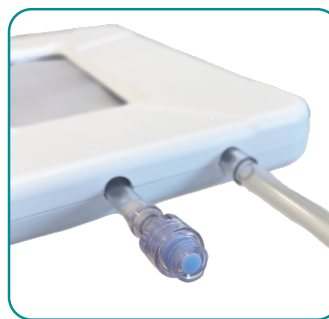

Synthetic bone substitutes based on nano-structured bio-mimetic hydroxyapatite
 Sostituti ossei di sintesi a base di idrossiapatite nano strutturata biomimetica



Dense granules
Granuli densi

	Size/Dimensione	Quantity/Quantità
NUB-D20501	1 – 2 mm	1 Btl. – 5,0 cc
NUB-D21001	1 – 2 mm	1 Btl. – 10 cc



Porous chips
Chips porose

	Size/Dimensione	Quantity/Quantità
NUB-P20501	1 – 2 mm	1 Btl. – 5,0 cc
NUB-P21001	1 – 2 mm	1 Btl. – 10 cc



Injectable paste with cannula
Pasta iniettabile con cannula

	Quantity/Quantità
NUB-PA5001	1 Syr. – 5,0 cc
NUB-PA10001	1 Syr. – 10 cc



Mouldable crunch
Crunch malleabile

	Quantity/Quantità
NUB-CR5001	1 Syr – 5,0 cc
NUB-CR10001	1 Syr – 10 cc

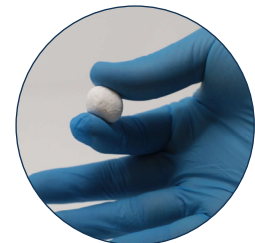

Synthetic bone substitutes based on nano-structured bio-mimetic hydroxyapatite Sostituti ossei di sintesi a base di idrossiapatite nano strutturata biomimetica

CODES UPON REQUEST
CODICI SU RICHIESTA



Dense granules Granuli densi

	Size Dimensione	Quantity Quantità
NUB-D20201	1-2 mm	1 Btl. – 2,0 cc
NUB-D22001	1-2 mm	1 Btl. – 20 cc
NUB-D23001	1-2 mm	1 Btl. – 30 cc
NUB-D24001	1-2 mm	1 Btl. – 40 cc
NUB-D25001	1-2 mm	1 Btl. – 50 cc



Porous chips Chips porose

	Size Dimensione	Quantity Quantità
NUB-P20201	1-2 mm	1 Btl. – 2,0 cc
NUB-P22001	1-2 mm	1 Btl. – 20 cc
NUB-P23001	1-2 mm	1 Btl. – 30 cc
NUB-P24001	1-2 mm	1 Btl. – 40 cc
NUB-P25001	1-2 mm	1 Btl. – 50 cc

Injectable paste with cannula Pasta iniettabile con cannula

	Quantity Quantità
NUB-D20201	1 Syr. – 2,0 cc
NUB-D22001	1 Syr. – 3,0 cc
NUB-D23001	1 Syr. – 14 cc



Mouldable crunch Crunch malleabile

	Quantity Quantità
NUB-CR2001	1 Syr. – 2,0 cc
NUB-CR3001	1 Syr. – 3,0 cc
NUB-CR14001	1 Syr. – 14 cc



Info

LSM-Med Srl
reserves the right
to make changes.

Info

LSM-Med Srl
si riserva il diritto
di apportare modifiche.



LSM-Med Srl

Strada Borrana 38
47899 Serravalle
Repubblica di San Marino
t: + 378 0549 961911
f: + 378 0549 961912
www.lsm-med.com
info@lsm-med.com



OVERMED Srl

Via Larga 13
20122 Milano
Italia
www.overmed.eu
info@overmed.eu